

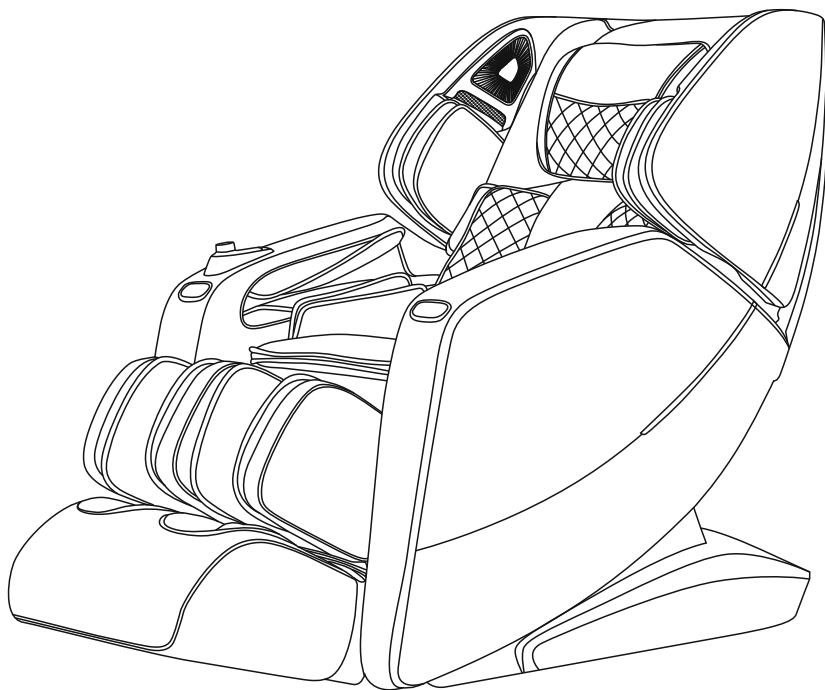

# Massaggio Stravagante 2

User manual





Thanks for purchasing this product. Please read this manual instruction carefully in order to know how to use this product correctly before operation. Please pay more attention to some important safety warning and keep this manual book properly for future use.

Note: Our Company reserves the right to revise the design and description of this product without any further notice. Please refer to the actual color of this product.

## CONTENTS

---

Safety and maintenance . . . . .	02-03
Use safety warning . . . . .	04-05
Name and function of components . . . . .	06
Function . . . . .	07
Remote interface introduce . . . . .	08-09
Method of usage: . . . . .	10
1. Switch power supply on . . . . .	10
2. Massage function control operation . . . . .	10-27
3. Handrail shortcut button introduction . . . . .	28-29
4. Voice control instruction . . . . .	30
5. Turn off power, stop massage . . . . .	31
6. Bluetooth Player Operation . . . . .	31
7. Installing the armrest . . . . .	31-33
8. Calf installation . . . . .	33-35
9. Head cushion and backrest pad's dismounting and use manual . . . . .	35
10. Floor protection . . . . .	36
11. Method of movement . . . . .	36
Product specification . . . . .	37

## Safety and maintenance

---



### 1. Important Safety Warning.

- Don't allow children to touch moveable part of this product.
- Please use well-grounding power supply suited to this product.
- Please pull out the plug after use or before cleaning to avoid injury or damage to the product.
- Please operate this product according to this manual instruction.
- Don't use accessories which are not recommended.
- Don't use this product outdoors.
- Please read this manual instruction carefully before operation.
- Any other usage that is not listed in this manual instruction is forbidden.
- 20 minutes of usage each time is recommended.
- Please don't use it if the leather is broken or damaged.
- Please don't use it if the cover or leather is damaged.
- Please don't use it if the radiator hole is covered or blocked.
- Please don't drop anything into this product.
- Please don't fall asleep while using this product.
- Please don't use it if drunk or feel unwell.
- Please don't use it within one hour after having meal.
- Please don't make the massage function too strong for avoiding Injury.

### 2. Environment for usage.

- Please don't use it under high temperature and moist environment such as bathroom.
- Please don't use it immediately while the environmental temperature changes sharply.
- Please don't use it under heavy-dusty or caustic environment.
- Please don't use it where there is not enough space or not good ventilation.

### 3. People who are not suitable to use this product.

- People who are suffering from osteoporosis are not suitable to use this product.
- People who are suffering from heart disease or carrying electronic medical equipment such as heart pacemaker are not suitable to use this product.
- People who are suffering from fever are not suitable to use this product.
- Pregnant women or women that are in menses period are not suitable to use this product.
- People who got injured or skin disease are not suitable to use this product.
- Children under 14-year old or people mentally unbalanced without being Supervised are not allowed to use this machine.
- People who are told by doctor to have rest or people who feel unwell are not suitable to use this product.
- People whose bodies are wet are forbidden to use this product.
- The appliance has a heated surface. Persons insensitive to heat must be careful when using the appliance.

## Safety and maintenance

---

### 4. Safety.

- Check the voltage if it is suitable to the specification of this product.
- Don't use wet hand to pull the plug.
- Don't make water go inside this product to avoid electric shock or cause damage to this product.
- Don't damage the wires or change the circuit of this product.
- Don't use wet cloth to clean the electric parts such as switch and plug.
- Be away from this product under power cut state to avoid injury if the power comeback suddenly.
- Stop using this product while it works abnormal, and please consult local agent immediately.
- Stop using this product if you feel unwell, and please consult health care doctor.
- This appliance is not intended for use by persons (including children) with reduced physical, sensory or mental capabilities, or lack of experience and knowledge, unless they have been given supervision or instruction concerning use of the appliance by a person responsible for their safety.
- Children should be supervised to ensure that they do not play with the appliance.
- If the supply cord is damaged, it must be replaced by the manufacturer, its Service agent or similarly qualified persons in order to avoid a hazard.

### 5. Maintenance.

- This product should be maintained by certain appointed agents, users are prohibited to disassemble or maintain by themselves.
- Please don't forget to cut the power after usage.
- Don't use this product if the socket looses.
- If this product will be left unused for long, please curl up the wires and reserve this product in dry and dustless environment.
- Don't reserve this product under high temperature or near fire and avoid longtime direct sunshine.
- If the detachable cord / supply cord is damaged, it must be replaced by the manufacturer, its service agent or similarly qualified persons in order to avoid a hazard.
- Please clean this product by dry cloth. Don't use thinner, benzene or alcohol.
- The mechanical components of this product are specially designed and made, it is not necessary to be specially maintained.
- Don't use edged res to thrust this product.
- Don't roll or pull this product above uneven ground, it should be lifted before moving.
- Please use it intermittently; don't make this product work continuously for long.

### 6. Solution of ordinary malfunctions.

- It is nature movement voice if the motor sounds while in usage.
- If the controller can't work normally, please check the plug and socket if they are connected strongly and make sure the switch is turned on.
- If the rated working time is over, the product will automatically activate the power-off button; If this product works continuously for long, the temperature protector will make the product automatically power-off, it should be used again after half an hour's rest.

## Use safety warning

---

### Warning

When the footrest lifting, people should not apply pressure on the footrest to avoid the massage chair falling forward to damage the product or cause personal injuries

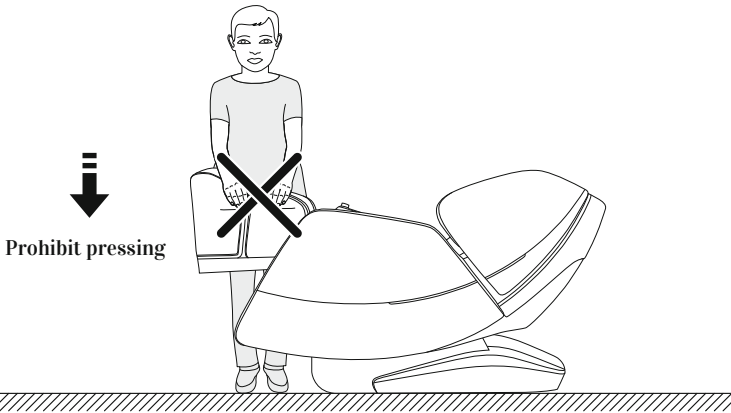

### Warning

Before sitting on the massage chair, Please make sure the massage hand cannot place in the seat position, so as avoiding the massage hand to damage the product or cause personal buttocks injuries.

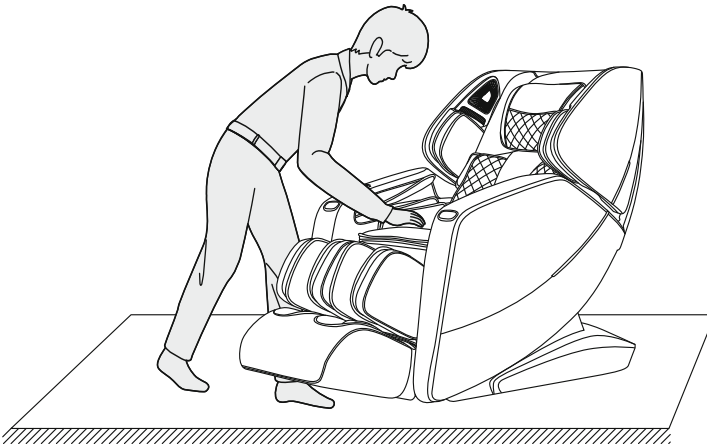

## Use safety warning

---

### Warning

Do not strive to pull out the control cable or power cord during standby or power-on state to avoid product damaged or electrocution accidents. Advise you unplug the controller cable and power cord and put away after you use the chair.

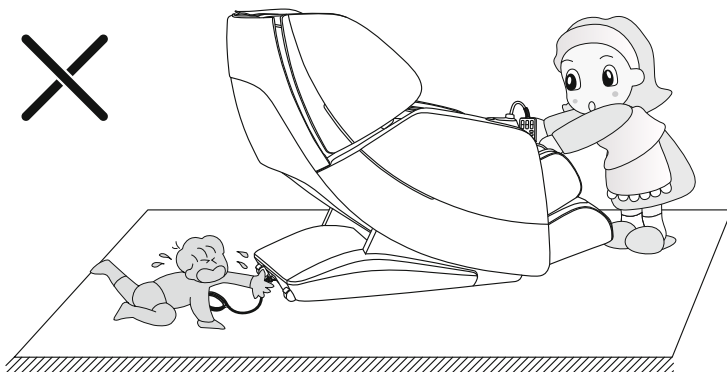

### Warning

When turning on the zero-gravity lying function, be sure to notice whether there are children or pets under the massage table under the bottom of the calf and the backrest to stay or play to avoid product damage and personal injury.

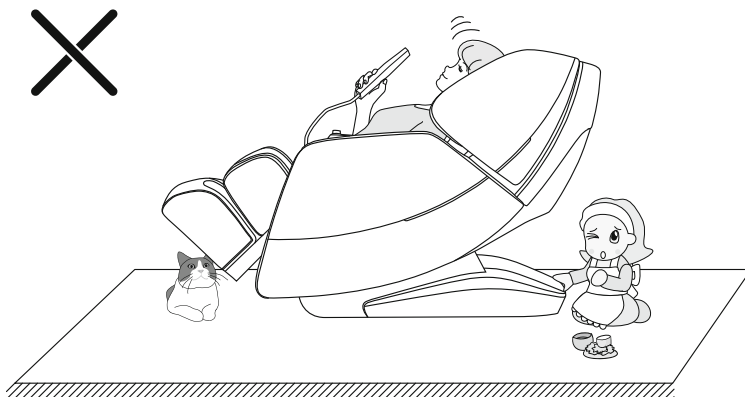

## Name and function of components

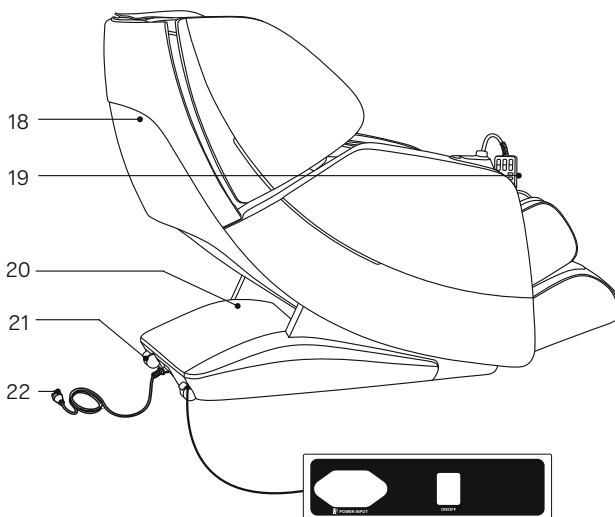
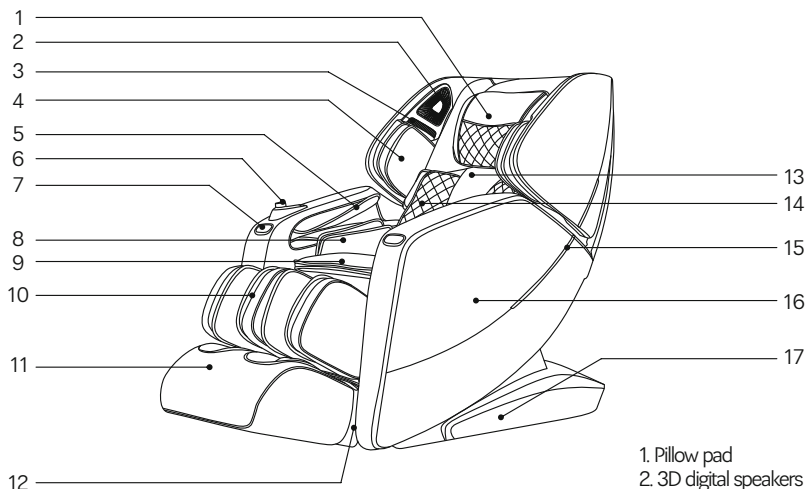

1. Pillow pad
2. 3D digital speakers  
(with voice control  
microphone on left)
3. O2 Ionizer
4. Upper arm air bag  
component
5. Arm air bag  
component
6. Shortcut button
7. Controller slot
8. Hip air bag  
component
9. Seat cushion
10. Calf rest
11. Foot rest
12. Calf sealing plate
13. Back cushion
14. Back air bag
15. LED lights
16. Armrest
17. Side panel
18. Back cover
19. Remote controller
20. PCB box cover
21. Wheels
22. Power cord  
and plug
23. Power cord  
socket
24. Power switch



## Function

---

- This product is designed with a intelligent and silent 3D massage hand that can move up and down, Thrust forward and Shrinking back .
- It can automatically detect the shoulder position and also can be adjust by manual
- Can have a humanized and scientific massage by detecting the human body curve and the position of the massage finger pressure point, and length of the massage hand of Thrust forward and Shrinking back.
- With eight special automatic massage functions: fast, comfort, relax, Stretch, Full body, shoulder and neck, back and waist and Full air pressure.
- Three memory functions: program memory I, program memory II, program memory III.
- The upper body manual massage function; there are five kinds of massage position options : full, partial, fixed point, upper back and lower back; shoulder grasp , kneading, tapping, shiatsu, kneading and tapping and 3D ;six massage techniques; the massage technique has five speeds that can be adjusted; when massaged in tapping and shiatsu, the robot massage hand have five level widths to be adjusted .
- Air massage function: arm pressure massage function (design with 12 airbags), upper arm air pressure massage function (design with 4 airbags), and three levels air pressure intensity adjustment.
- Lower body air massage function: waist pressure massage function (design with 4 airbags), leg air pressure massage function (design with 22 airbags), foot air pressure massage function (design with 18 airbags), and three levels air pressure intensity adjustment.
- The back and calf heating function uses carbon fiber as an infrared heating source.
- This product is designed with Zero wall function , the chair will slide forward when backrest lie down.
- The backrest rail adopts "SL" rail technology, which fits perfectly with the curve of the back of the human body and can enjoy close-fitting massage from the head to the thigh.
- Intelligent voice control and identification function.
- Music play system: design with 3D digital speaker on the left and right arms.
- Can also play music by connect with Bluetooth of smart phone or other smart device
- Waist Twisting function: it uses the Left and right waist airbags to swing the waist , which relieves sedentary and causes tension in waist muscles.
- The right armrest is provided with a negative oxygen ion button, raise button, recline button, Zero Gravity button, pause button, automatic mode button, foot adjustment button, and calf adjustment button.
- Leg lifting or recline adjustment, lifting or recline adjustment of leg and back, Zero Gravity I or Zero Gravity II.
- Foot Roller massage function: at the bottom of foot, two pairs of mastoid rotating massage on toe root; scraping massage on the arch and heel.
- The footrest is equipped with an automatic sensor to detect the leg length. When the calf is raised or down to a suitable angle, the footrest will automatically detect the length of the leg and detect the most comfortable massage area.
- Armrest LED light decoration
- Configuring a O2 Ionizer at right armrest
- The upper arm is provided with a width adjustment function, which is adjusted in two steps (when it reaches the innermost position, the arm is pushed in about one gear to release the hand, the are is automatically reset, and so on), adapting to different shoulder widths.
- Shutdown automatic reset function, massage robot automatic reset function.
- Configuring TFT color screen manual controller

## Remote interface introduce

---

### Remote controller display part

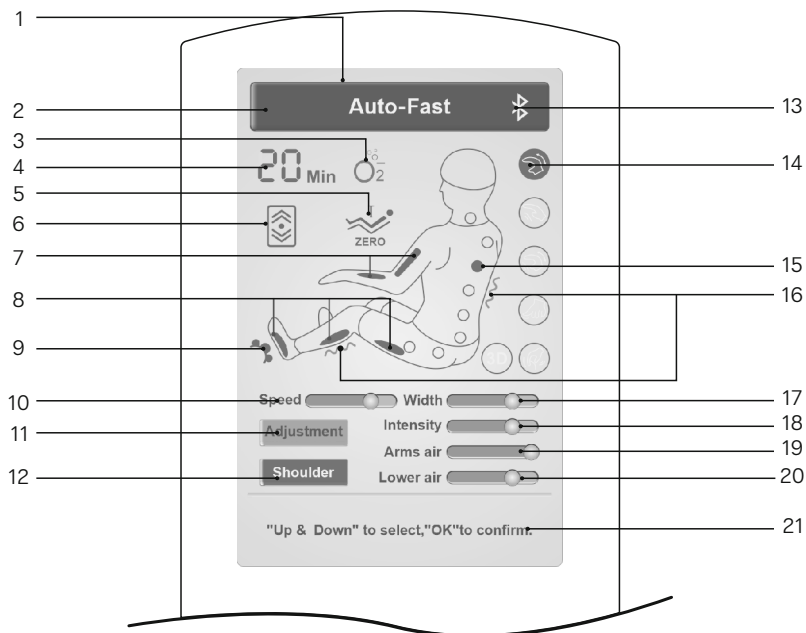

**Note: Remote Control shows the color, massage function and massage function icon typesetting. Please be subject to the actual products!**

- |                                      |  |
|--------------------------------------|--|
| 1. TFT color liquid crystal display  | 12. Shoulder position adjustment       |
| 2. Massage status display            | 13. Bluetooth display                  |
| 3. Negative oxygen ions display      | 14. Massage modes display              |
| 4. Timing display                    | 15. Massage position display           |
| 5. Zero gravity display              | 16. Leg and back heating display       |
| 6. The back adjustment display       | 17. Width adjustment                   |
| 7. Arm air pressure display          | 18. Massage strength adjustment        |
| 8. Leg and foot air pressure display | 19. Arm air pressure adjustment        |
| 9. Foot roller display               | 20. Lower body air pressure adjustment |
| 10. Speed adjustment                 | 21. The status bar                     |
| 11. Adjustment                       |  |

## Remote interface introduce

---

### Part of hand controller button

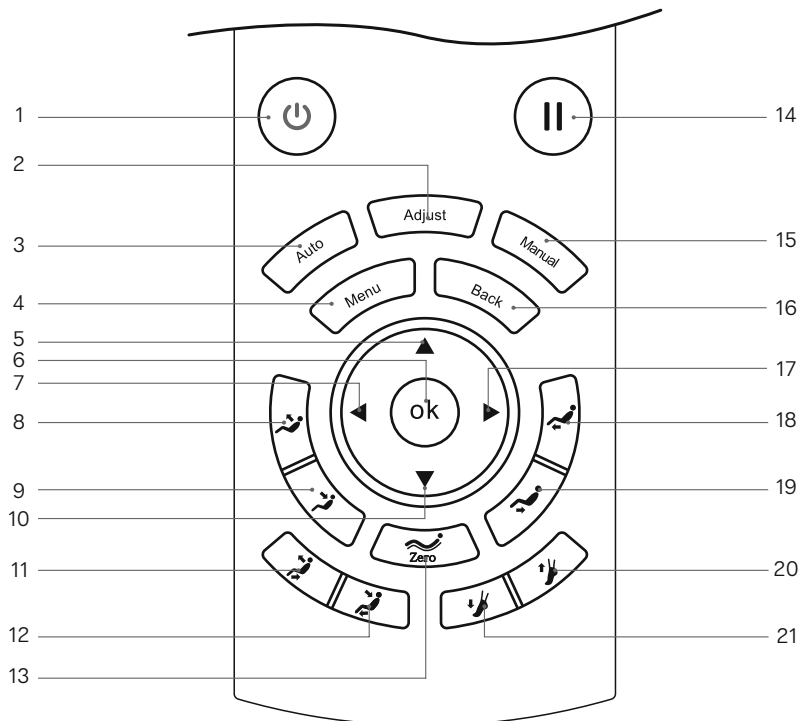

1. Power button: turn on or off massage chair
2. Adjustment button: enter the massage function selection interface
3. Auto button: enter the automatic mode selection interface
4. Menu button: enter main menu interface
5. Up button: navigation key up
6. OK button: OK.
7. Left button: navigation key turn left
8. Backrest rise button: adjust the backrest rise
9. Backrest down button: adjust the backrest down
10. Down button: navigation key down
11. Sit up button: massage chair link up

12. Lying down button: massage chair link down
13. Zero gravity button: adjust massage chair zero gravity
14. Pause button: Pause all the function
15. Manual button: enter the manual mode selection interface
16. Return button: return to massage information interface
17. Right button: navigation key turn right
18. Calf rest up button: adjust calf rest up
19. Calf rest down button: adjust calf rest down
20. Foot rest shorten button: adjust foot rest short
21. Foot rest elongate button: adjust foot rest elongation.

## Method of usage

### 1. Switch power supply on

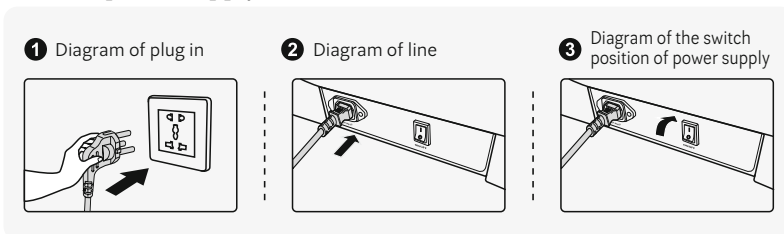

### 2. Massage function control operation

#### 1). Standby

- After the massage chair cannot enter any mode operation in standby mode.

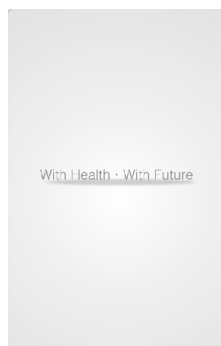

#### 2). Start to massage

- Press "Power" button to start massage, enter the boot screen, backrest maintains the default position, calf rest raise slightly, choosing certain auto mode to start massage. The massage chair will shut down automatically if auto mode is not selected within 5 minutes.

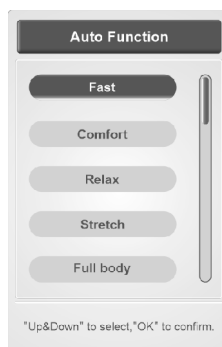
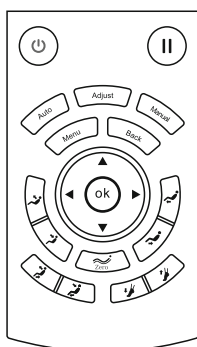

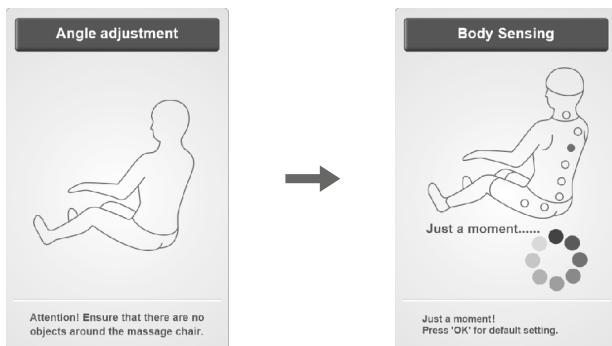

## Method of usage

- Choose one automatic mode, backrest and calf position will adjust to fixed angle.
- After adjusting the angle, massage chair will automatically detect the shoulder position and body (note: fast mode only detect shoulder position, other modes detect whole body and shoulder position), waiting the detection finish. If press "ok" button, massage chair will direct start to massage in default without shoulder position and body sensing.

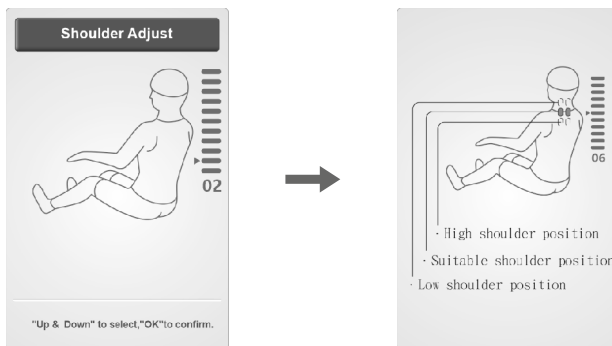

- After testing the shoulder position, sounded with "di-di-di" notification tone, you can adjust the shoulder position by press up or down button according to users' height in small scale. There have 11 levels for shoulder adjustment. If without adjustment in 10 seconds, then into the massage function automatically. Or directly press "ok" button enter the massage immediately. If massage chair does not test shoulder position, the massage will start with default position.



Button	Description
	Move the massage balls upward to a suitable position.
	Move the massage balls downward to a suitable position.

## Method of usage

- After entering the massage modes, the shoulder position can adjusted in shoulder adjustment interface when at the operating status interface.

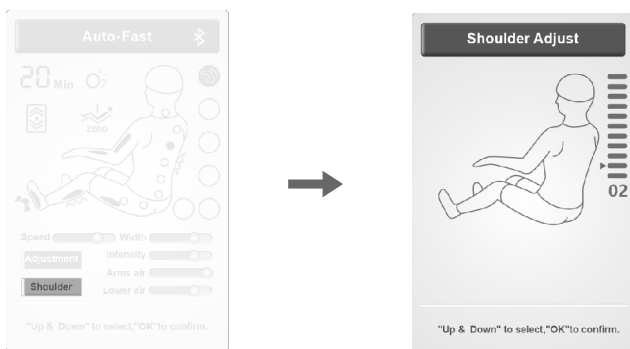

### 3). Pause button

- In massage process, press "Pause" button, all the massage function will Pause; press it again, it will go with massage function before Pause. If the Pause time exceed 20 minutes, all the massage function will turn off.

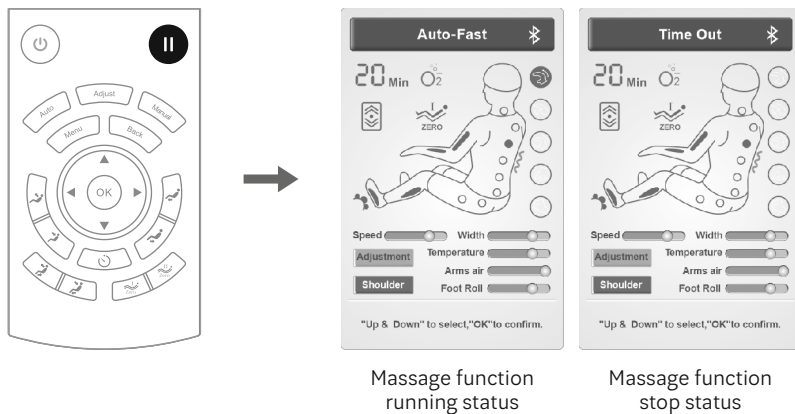

## Method of usage

### 4). Menu button

- “Menu” button to enter the main menu message function selection interface includes automatic function, manual mode, adjustment, customize, set, equipment information function interface.
- Press “up” or “down” button choose the menu, press “ok” button to confirm enter the choosing menu interface. Press “return” button to return the function selection information interface.

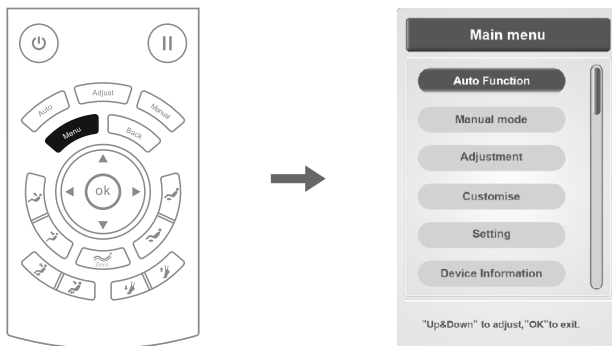

### 5). Automatic function (automatic button also can press directly to automatic function interface)

- Press “menu” button to enter main menu interface, choosing automatic function icon: automatic mode include eight kinds such as fast, comfortable, relax, traction, whole-body, shoulder and neck, back and waist and full pressure.
- Press “up” or “down” button to choose message function, press “ok” button to confirm enter the choosing message function. Press “return” button to return to function selection information interface.

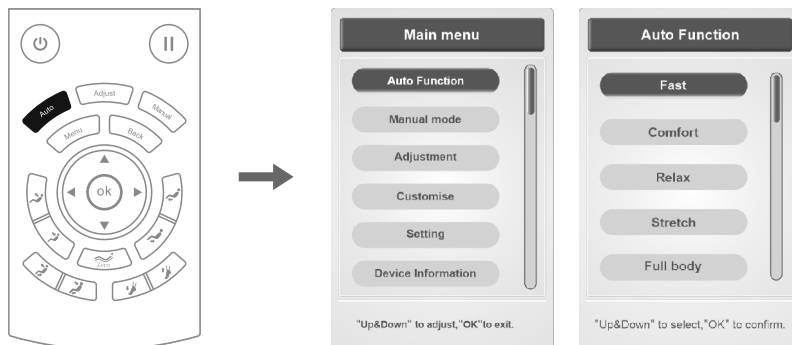

Note: the choosing automatic massage function will display in message function status bar, press “return” button to check the operating.

## Method of usage

Function	Description
Fast massage	Fast to experience all the massage effect.
Comfort massage	The most comfortable massage experience.
Relax massage	Gentle and comfortable depth massage to relax body and relieve tired.
Traction massage	It uses the waist airbag pressure to swing around to form a twisting massage function, which relieves sedentary and causes tension in waist muscles.
Whole body massage	Depth massage, recall body energy.
Neck& shoulder massage	Point to neck and shoulder massage mode, relieve muscles sore and tired be useful effective massage.
Back & waist massage	Focus on the back and waist massage to relieve back and waist sore.
Full pressure massage	Focus on the upper arm, arm, knee, leg and foot to relax full body.

### 6). Manual mode (manual button directly enter manual mode interface)

- Press "menu" button to enter main menu interface, choose manual mode icon: include massage mode, massage position, air pressure and other massage function.
- Press "left" of "right" button to change submenu, then press "up" or "down" button to choose massage function, press "return" button to return operating information interface.

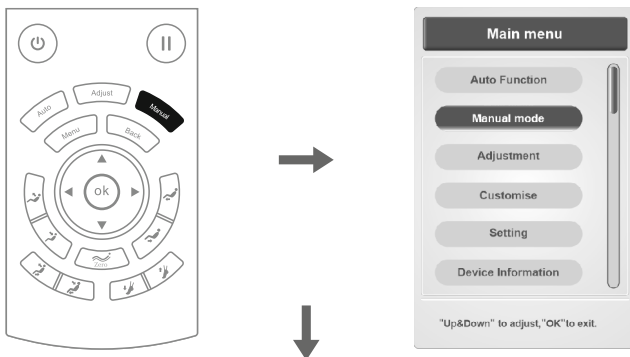



## Method of usage

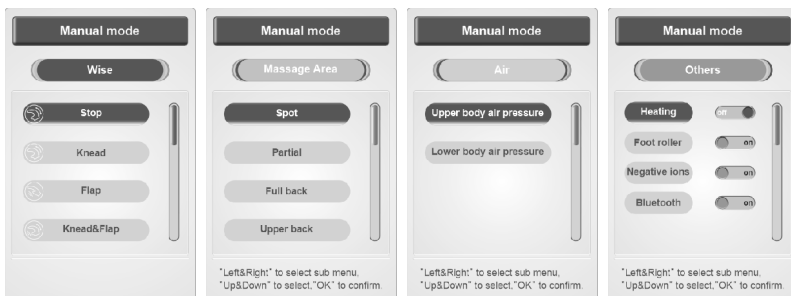

### A. Manual mode (manual button-massage mode)

- Includes eleven massage modes, such as kneading, tapping - 2 types, kneading with tapping, shiatsu - 2 types, 3D - 4 types, shoulder lifting. In tapping and shiatsu mode, the width can be adjusted. Other massage modes can adjust the speed except stop.
- Press "up" or "down" button to choose massage mode icon, press "ok" button to confirm the massage mode is starting.

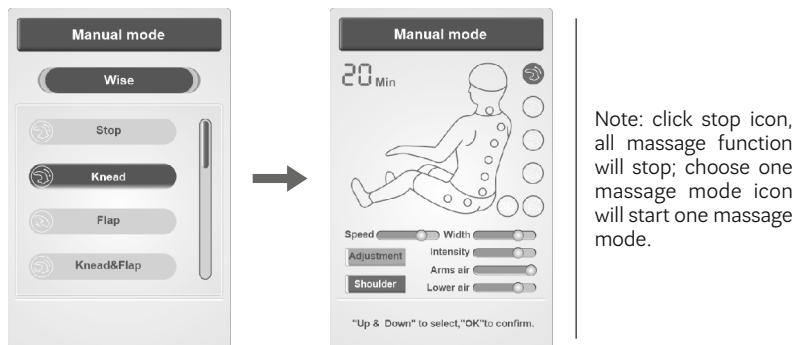

Function	Description	
Kneading	Speed	5-level speed adjustable 5-level width adjustable
Tapping (2 types)	Speed and width	
Kneading and tapping	Speed	
Shiatsu (2 types)	Speed and width	
Shouleder lifting	Speed	
3D (4 types)	Speed and width	

## Method of usage

### B. Manual mode (manual button-massage position)

- Manual mode(massage position): massage fixed point, partial, full back, upper back and lower back.
- Press "up" or "down" button to choose partial massage function icon, press "ok" button to confirm.

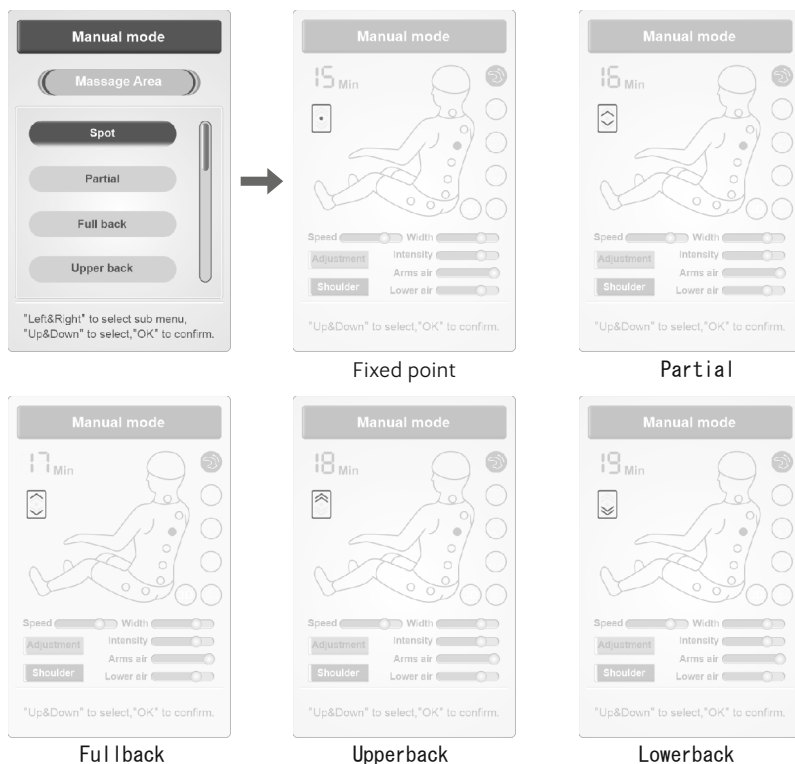

Function	Description	
Fixed point	Massage at fixed point	When choosing the mode of fixed point and partial massage, press "up" and "down" button to adjust massage range.
Partial	Partial massage back and forth in small range	
Upper back	Upper back massage back and forth	
Lower back	Lower back massage back and forth	
Full back	Full back massage back and forth	

## Method of usage

### C. Manual mode (manual button-air pressure)

- Manual mode(air pressure): include upper body air pressure and lower body air pressure massage function.
- Press "up" or "down" button to choose different air pressure massage function, press "ok" button to confirm.

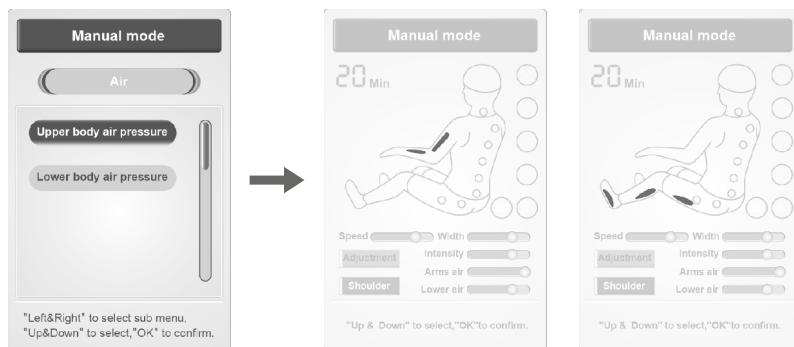

Function	Description
Upper body air pressure	Switch on or off upper body air pressure massage function
Lower body air pressure	Switch on or off lower body air pressure massage function

### D. Manual mode (manual button-extra)

- Manual mode(extra): include heating, foot roller, negative oxygen ions, Bluetooth and so on massage function.
- Press "up" or "down" button to choose massage function, press "ok" button to switch on or off the massage function.

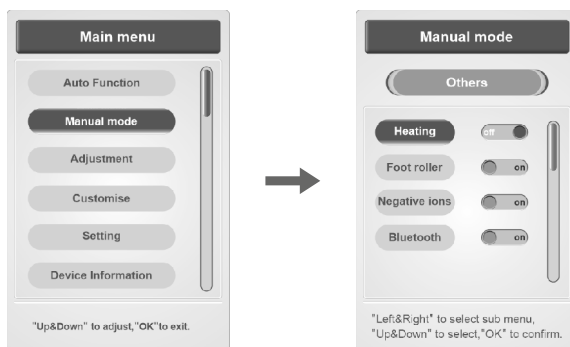

## Method of usage

---

### · Manual mode (extra-back heating)

- Press "confirm" button to choose switch on or off heating massage function, start 3 minutes will have warm.
- Press "up" or "down" button to choose other massage function, press "return" button to return the operating information interface.

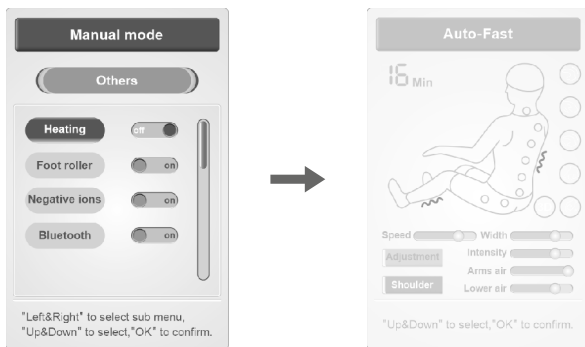

### · Manual mode (extra-foot roller)

- Press "confirm" button to choose switch on or off foot roller massage function.
- Press "up" or "down" button to choose other massage function, press "return" button to return the operating information interface.

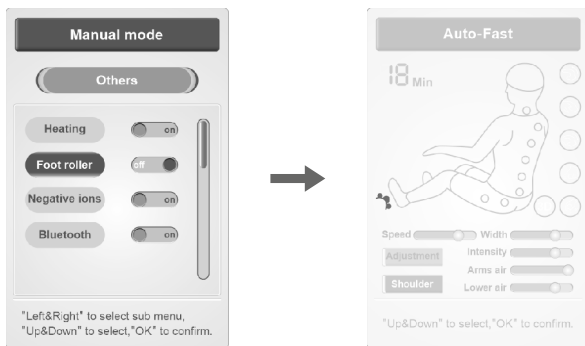

## Method of usage

---

### · Manual mode (extra-negative oxygen ions)

- Press "confirm" button to choose switch on or off negative oxygen ions massage function.
- Press "up" or "down" button to choose other massage function, press "return" button to return the operating information interface.

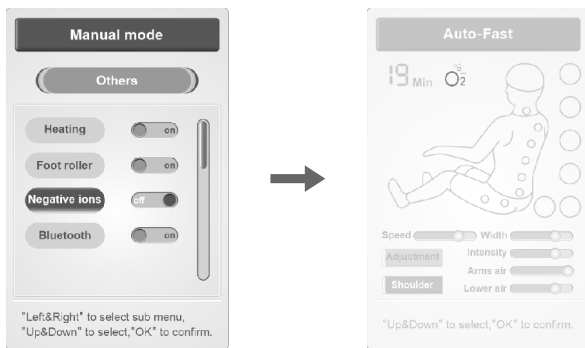

### · Manual mode (extra-Bluetooth)

- Press "confirm" button to choose switch on or off Bluetooth function.
- After connect the Bluetooth in massage chair with source device which have Bluetooth. The Bluetooth function of the smart device can be used to play music on a wireless connection.
- Press "up" or "down" button to choose other massage function, press "return" button to return the operating information interface.

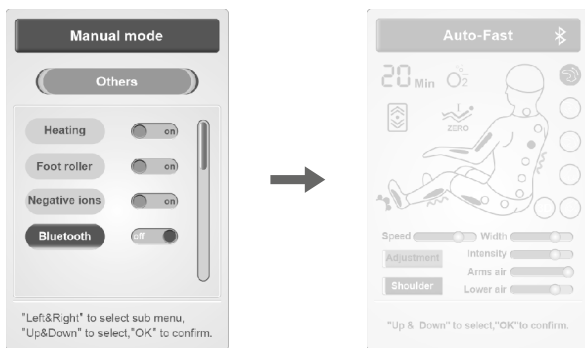

## Method of usage

### 7). Adjustment function (adjust button-directly press "adjust" button to enter adjustment function interface)

· Press "menu" button to enter main menu interface, choose adjustment function icon: include massage mode, massage range, massage intensity and other massage adjustment function.

· Press "left" or "right" button switch to submenu function, choose massage function in menu, then press "up" or "down" button to select adjust function. Press "ok" button to confirm or press "return" button to return to operating information interface.

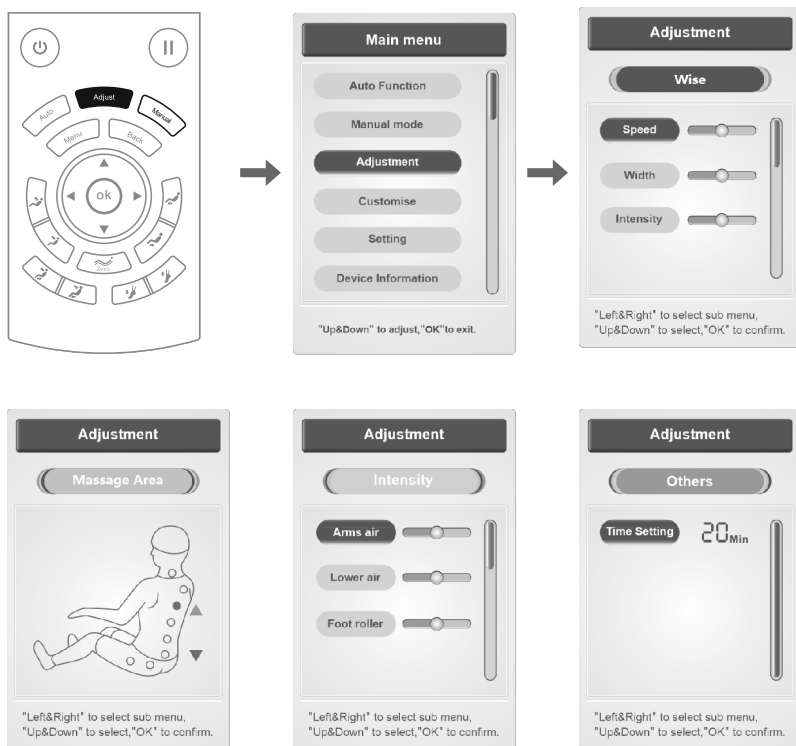

When at operating information interface, press "adjust" button directly enter adjustment interface.

## Method of usage

---

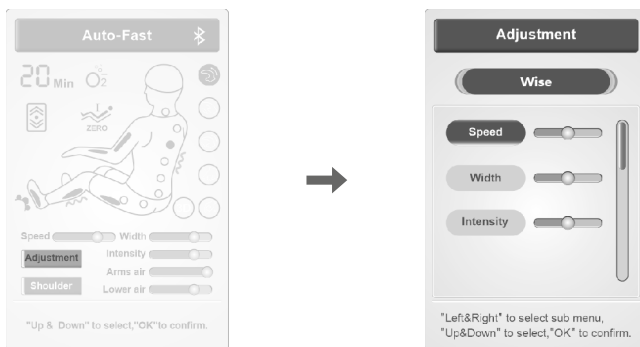

### A. Adjustment function (adjust button-massage mode)

- Adjustment function(massage mode): adjust massage mode include speed, width, intensity and so on.
- Press "up" or "down" button to choose speed or width function, press "ok" button to adjust speed and width levels.

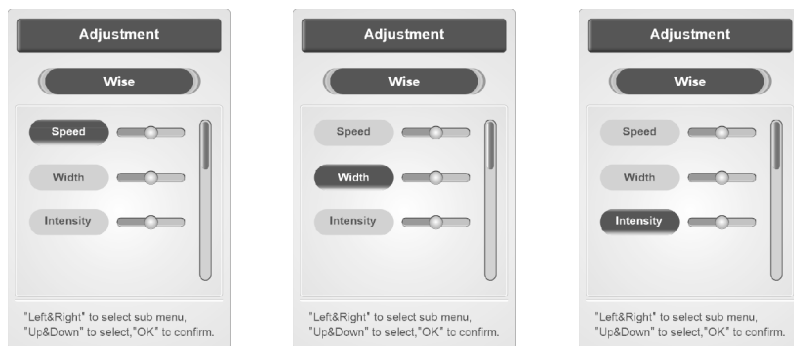

#### Note:

- Speed: five levels for massage speed adjustment.
- Width: five levels for massage width adjustment when in tapping and shiatsu mode.

## Method of usage

---

### B. Adjustment function (adjust button-massage range)

- Adjustment function(massage range): when at fixed point or partial massage range, press "up" button not release the massage head will rise or stop; press "down" button not release the massage head will go down or stop.
- Press "up" or "down" button to adjust massage range.

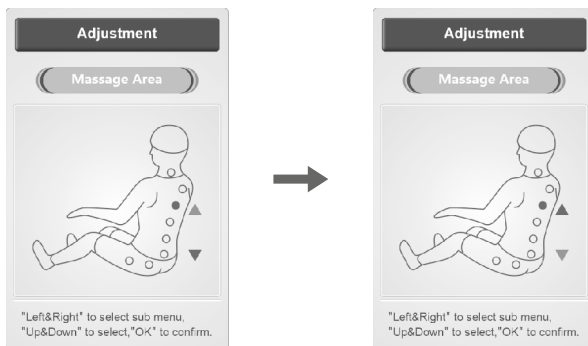

### C. Adjustment function (adjust button-intensity)

- Adjustment function (adjust button-intensity): include upperbody air pressure, lower body air pressure, foot roller. There have three levels to adjust.
- Press "up" or "down" button to choose air pressure intensity or foot roller intensity, press "ok" button to adjust intensity.

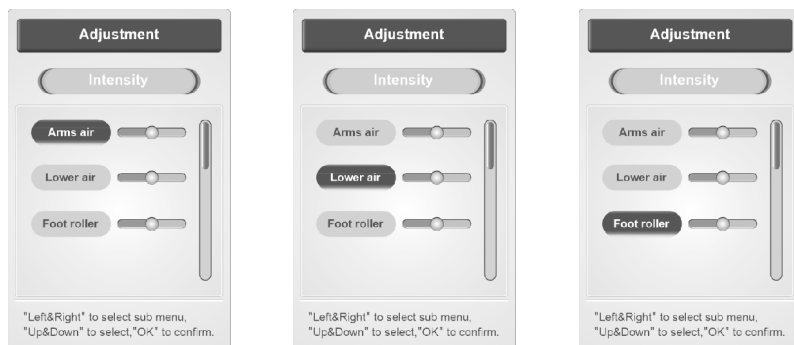



## Method of usage

---

### D. Adjustment function (adjust button-other adjustment)

- Adjustment function (other adjustment): timing at present. Press "confirm" button one time with 5 minutes added. When above 40 minutes, it will return to zero.
- Press "ok" button to adjust time (press "ok" button one time, 5 minutes added, 5 at least, 40 at most, in turn)

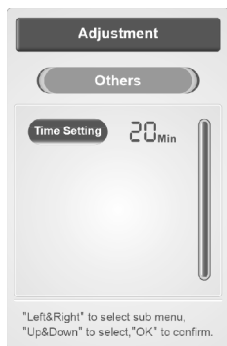

### 8). Customize

- Press "menu" button to enter main menu select "customize" function, enter customize function interface include storage and transfer function such as program memory I, program memory II, program memory III.
- Press "left" or "right" button to choose storage or transfer, press "ok" Button to confirm.
- Press "up" or "down" button to choose program memory I, program memory II, program memory III.
- Storage: save all current massage mode, air pressure, angle and other massage function.
- Transfer: retrieval previous massage mode, air pressure, angle and other massage function.
- Press "return" button to return operating information interface.

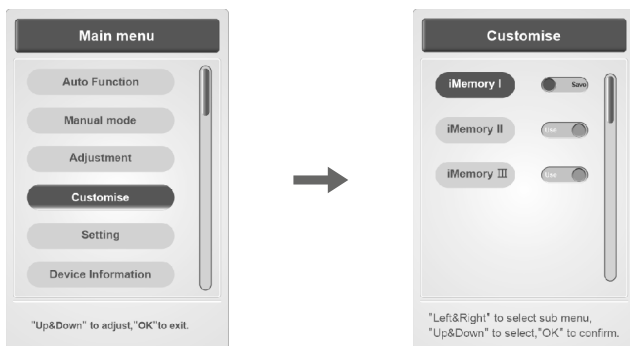

## Method of usage

---

### 9). Setting

- Press "menu" button to enter main menu interface, choose "setting" function icon, enter setting interface include language, backlight, lock screen and so on.
- Press "left" or "right" button to switch to submenu. Press "up" or "down" button to select function or press "return" button return to operating information interface.

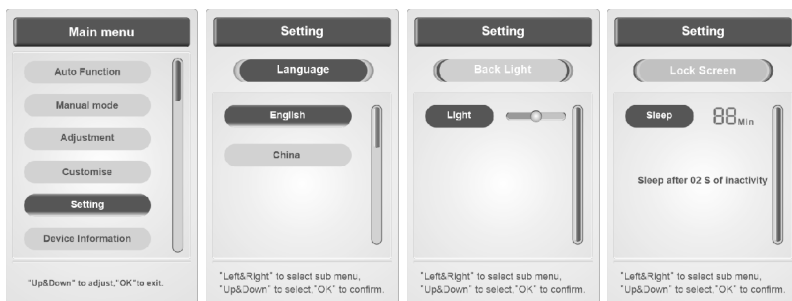

### A. Setting (language)

- Setting(language): set Chinese or English language.
- Press "up" or "down" button to choose one language, press "ok" button to confirm.

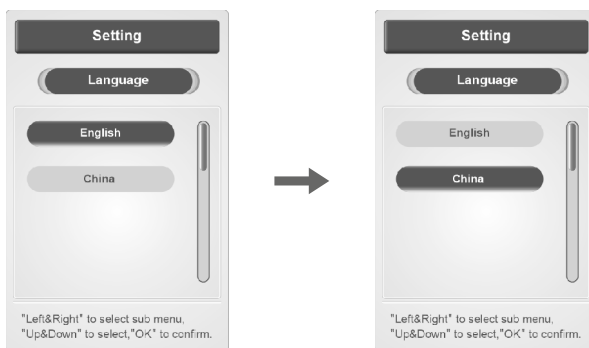

## Method of usage

---

### B. Setting (lock screen)

- Setting (lock screen): include time or never lock, automatic lock without any operating in 2 seconds.
- Press OK button on the remote control to adjust the screen lock time , The screen lock time will be start from 15sec , 30sec , 1min , 2min or never locked by each single press .

### C. Setting (backlight)

- Setting (backlight): five levels for light adjustment.
- Press "return" button return to operating information interface.

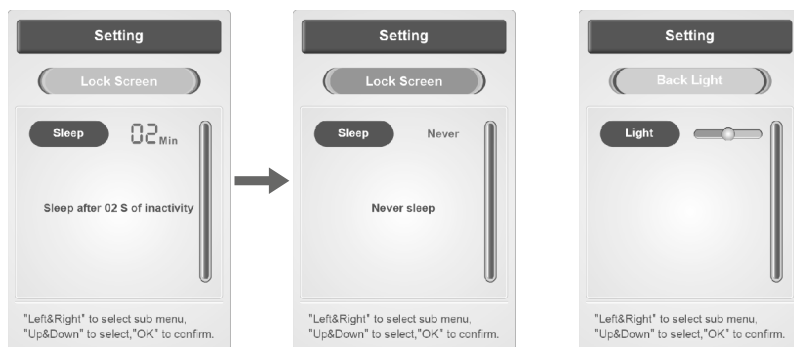

## 10). Equipment information

- Press "menu" button to enter main menu interface to choose equipment information function, display current equipment information.
- Press "up" or "down" button to select, press "ok" button to confirm. Press "return" button return to operating information interface.

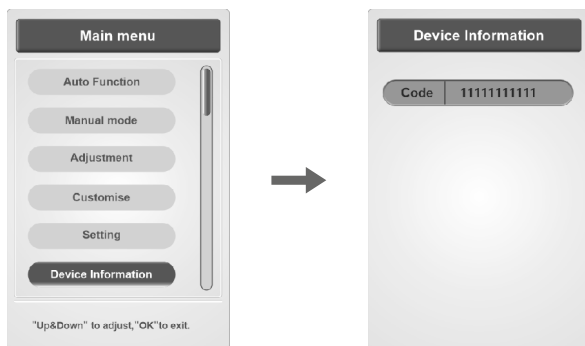



## Method of usage

### 11). Zero Gravity button

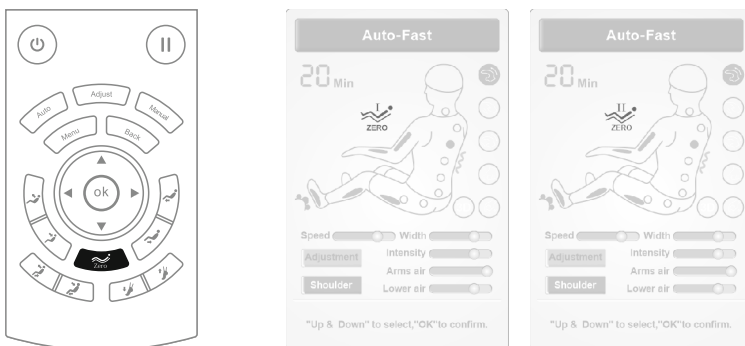
- Press "Zero Gravity" button to adjust Zero Gravity position, choose "Zero Gravity I" or "Zero Gravity II" according to your requirement.



Function	Description
	Zero Gravity i: adjust to Zero Gravity i angle.
	Zero Gravity ii: adjust to Zero Gravity ii angle.

### 12). Return button



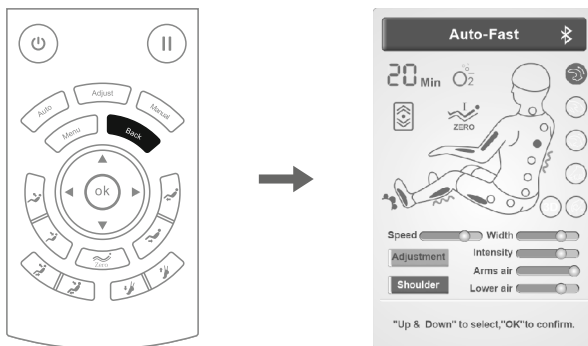





- When adjust massage function, if you want return to operating information interface, press "return" button.



## Method of usage

---

### 13). Angle adjustment button

Function	Description
	Calf rest up button: press to rise, release to stop; when it finished, it will automatically detect foot length.
	Calf rest down button: press to go down, release to stop; when it finished, it will automatically detect foot length.
	Backrest up button: press to rise, release to stop.
	Backrest down button: press to go down, release to stop.
	Link up button: press to rise backrest with calf rest go down, release to stop; when it finished, it will automatically detect foot length.
	Link down button: press to get down backrest with calf rest rise, release to stop; when it finished, it will automatically detect foot length.
	Zero gravity button: press to adjust calf rest and back rest position to zero gravity position, there have two modes, in turn.
	Foot rest shorten button: press to manually adjust foot rest to be short, release to stop.
	Foot rest elongate button: press to manually adjust foot rest elongation, release to stop.

## Method of usage





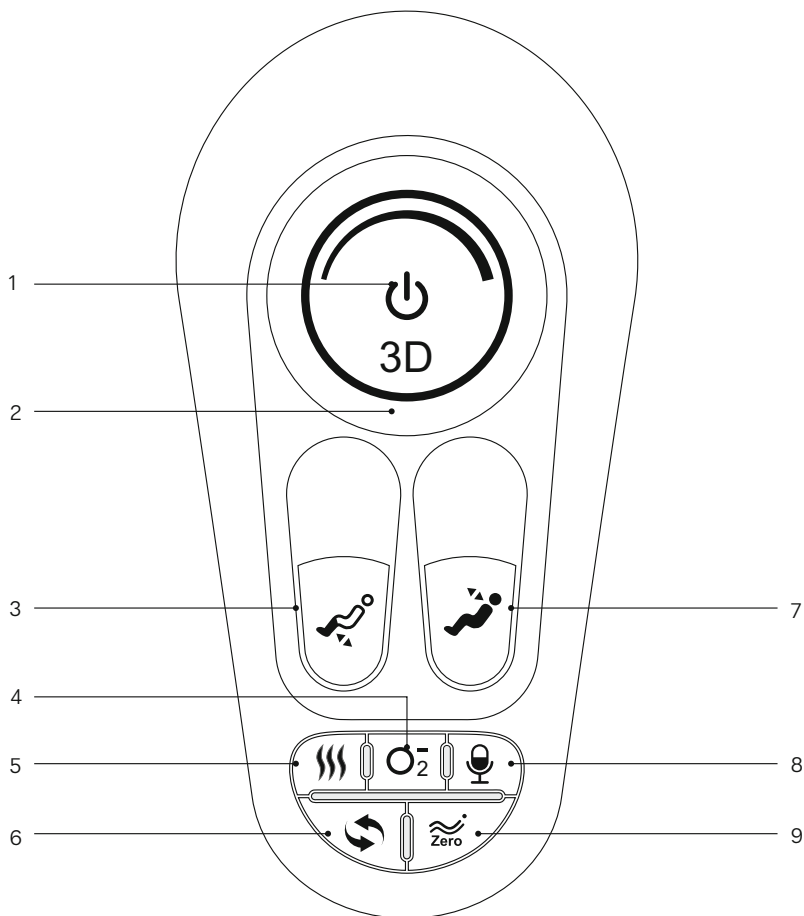



---

### 3. Handrail shortcut button introduction



1. Power button: switch on (press it in seconds to stop) or off massage chair.
2. 3D intensity button: 3D intensity adjustment.
3. Foot rest stretch button: adjust the length of foot rest.
4. Negative oxygen ions button: switch on or off negative oxygen ions.
5. Heating button: switch on or off heating.
6. Automatic button: switch on or off massage function.
7. Link down button: adjust lying down angle.
8. Voice button: switch on voice control massage function.
9. Zero gravity button: adjust zero gravity angle.

## Method of usage

Function	Description
	Power button: press in a second to stop, press in 3 seconds to switch on or off. If the pause time exceeds 20 minutes, all massage function are automatically turned off.
	3D intensity button: 3D massage strength, that is, the massage head is extended forward or the whole is retracted.
	Foot rest shorten button: press to rise foot rest to shorten it, release to stop.
	Foot rest elongate button: press to get down foot rest to elongate it, release to stop.
	Link up button: lift up button to rise back rest with calf rest go down, release to stop; when it finished, it will automatically detect foot length.
	Link down button: press button to get down back rest with calf rest rise, release to stop; when it finished, it will automatically detect foot length.
	Heating button: switch on or off heating function.
	Negative oxygen ions button: switch on or off negative oxygen ions function.
	Voice button: switch on or off voice control massage function.
	Automatic mode button: press to switch automatic massage function everytime.
	Zero Gravity button: automatically adjust calf rest and back rest to Zero Gravity position, there have two Zero Gravity lying down mode in turn.

## Method of usage

---

### 4. Voice control instruction

- When the massage chair is turned on or in standby mode, say "Alice Alice" to wake up the voice control function.
- After the successful wake-up, the massage chair will reply "I am here". At this time, the voice control entry corresponding to the function is realized within 6 seconds. After the massage chair is respond, the corresponding voice control function can be realized; if did not correctly say any voice entry for more than 6 seconds, the voice control function automatically turns off and needs to be reawakened.
- Note: When waking up the voice control function, please use Mandarin, the speech rate is moderate, Voice commands should be follow up the Voice entry.

Voice control enter		
Awakening words: "hi Alice". Answer: I am here.		
Serial No	Voice control entry	Answer entry
1	Massage on	Answer: Ok, massage on.
2	Massage close	Answer: Ok, massage close
3	Comfort Massage.	Answer: ok, comfort massage
4	Relax massage.	Answer: ok, relax massage
5	Full body massage.	Answer: ok,full body massage
6	Neck and shoulder massage.	Answer: ok,Neck and shoulder massage
7	Back and waist massage.	Answer: Ok,back and waist massage
8	Stretch massage.	Answer: ok,stretch massage
9	Fixed massage.	Answer: ok,fixed massage
10	Change the other mode.	Answer: Ok, change the other mode
11	Go little down.	Answer: Ok, go little down
12	Go little up.	Answer: Ok, go little up
13	Open the air pressure.	Answer: OR, Open the air pressure
14	Close the air pressure.	Answer: OR , Close the air pressure
15	Up the seat position.	Answer: Ok, Up the seat position
16	Down the seat position.	Answer: Ok, Down the seat position
17	Stop adjustment.	Answer: Ok, stop adjustment



## Method of usage

---

### 5. Turn off power, stop massage

- During the massage process, press the power switch key to immediately turn off all massage functions, the seat back and the foot pad are reset, the massage time is up, and all massage functions are immediately turned off, and the seat back and the foot pad are not reset.
- Cut off the power supply of the whole machine, the figure (schematic diagram of the whole machine power cut).

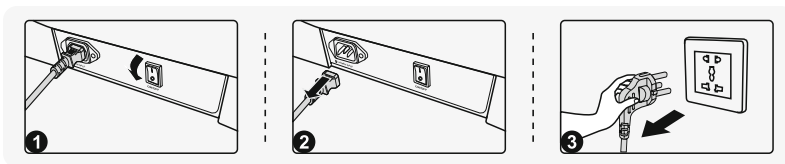

- ❶ Schematic diagram of the whole machine power turning off.
- ❷ Schematic diagram of unplugging the whole machine wiring.
- ❸ Schematic diagram of unplugging the power plug.

### 6. Bluetooth Player Operation

1. Enter the smart device manual and open the Bluetooth function to search the new Bluetooth devices .
2. Will find the bluetooth named like (IMCM-XXXX),choose it to pair with the chair .
3. Turn on the Music Player in the smart device.

### 7. Installing the armrest

1. Locate the connector plug corresponding to the armrest from the bottom of the frame and pass it out from the center of the rear end of the frame (figure 1).
2. After passing the connector plug from the middle of the rear end of the frame, corresponding to each pair of wiring plugs (docking according to the mark on the physical pair wiring) (figure 2).

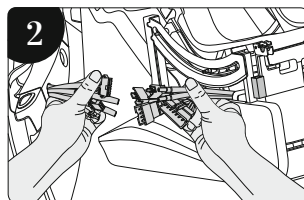
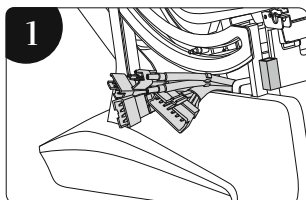

## Method of usage

---

3. The connector from the bottom of the frame is inserted firmly with the armrest connector, and the air pipe connector is also inserted into the position (figure 3).
4. After connecting with the corresponding connecting wires, gently insert the middle of the steel pipe behind the frame steel frame into the bottom of the frame by hand, and take care to avoid the air pipe collapse (figure 4).

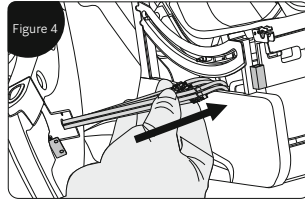
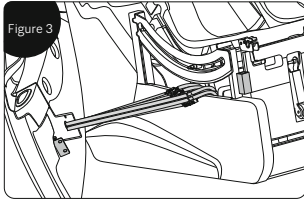

5. Hold the front and rear ends of the armrests with both hands, first insert the limit shaft at the rear end of the armrest into the limit shaft card at the lower end of the back steel frame, then push the armrest up slightly by hand and check whether the armrest limit shaft is firmly inserted (figure 5).
6. After inserting the rear end of the armrest, hook the front end of the armrest into the steel tube of the seat frame and press down on the front end of the armrest; then gently shake the armrest to check whether the front and rear ends of the armrest are in place (figure 6).

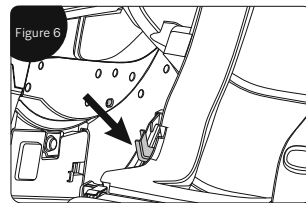
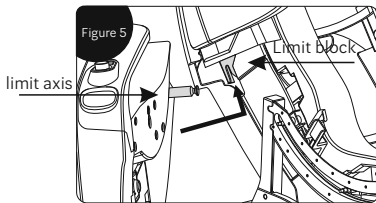

7. Put hook up of the steel frame at the front inside frame steel tube (figure 7), then shake the armrest lightly to check whether the front and rear of armrest installing in right place.
8. Open the long holes inside armrest leather case and then tighten armrest with two M5X14-12.9 screws and a 6X12X1.5 flat pad by supplied 4# hex wrench (figure 8).

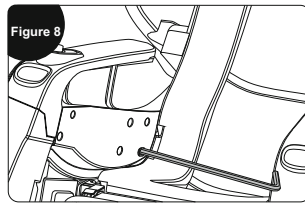
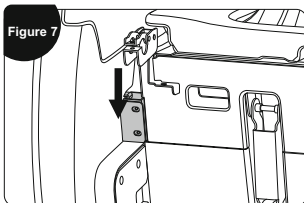

## Method of usage

---

9. Align the mounting holes on the steel frame at the front end of the fixed armrest, and then tighten armrest and frame steel tube with two M5X14-12.9 screws and a 6X12X1.5 flat pad by supplied 4# hex wrench (figure 8).

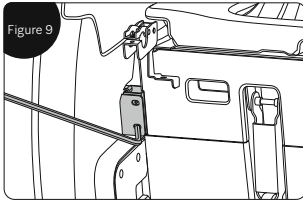

## 8. Calf installation

1. Cut the connecting wire and the air pipe tie fixed on the steel pipe first (Figure. 1).
2. Connect the connecting wire and the air pipe and the leg joint in the lower end of the frame, and confirm whether the docking is in place. Then insert the docking cable and the air pipe from the lower end of the frame into the lower side of the frame, and pay attention to the plug. Avoid tracheal dying when entering (Figure 2).

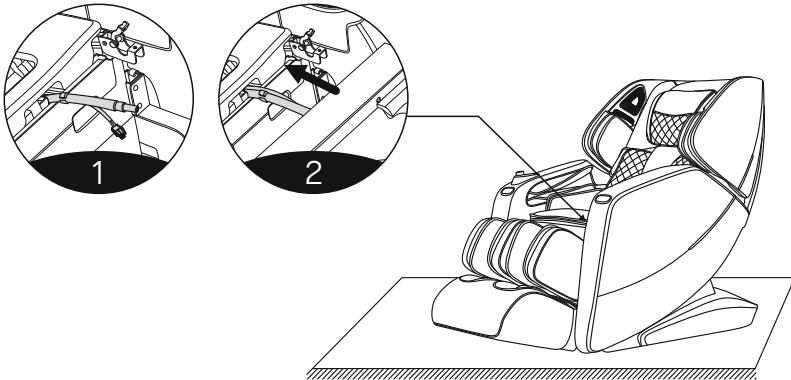

## Method of usage

---

3. Insert the rotating inner sleeve and the rotating outer sleeve into the left side of the calf and the right side of the lower leg (note: the large step must face inward) (Figure 3).
4. Open the calf support hinge cover on the left and right mounts of the massage chair (Figure 4).

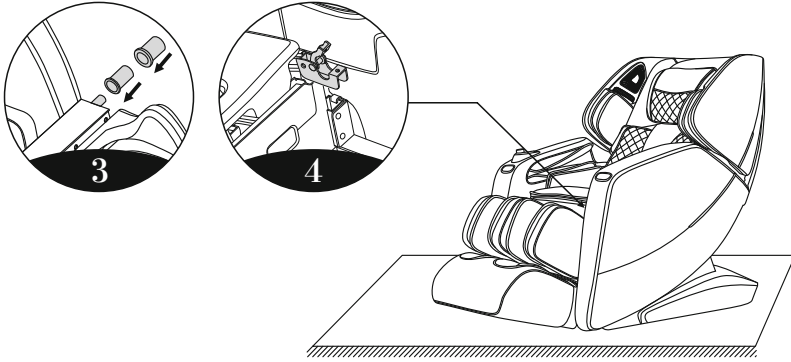

5. Then hang the lower leg (left and right shaft) into the frame support hinge plate at the same time (figure 5).
6. Cover rotating shaft cover, press calf rotating cover, and then tighten calf rotating cover board with two M5×14-12.9 screws and a 6×12×1.5 flat pad by supplied 4# hex wrench. (Fig. 6)

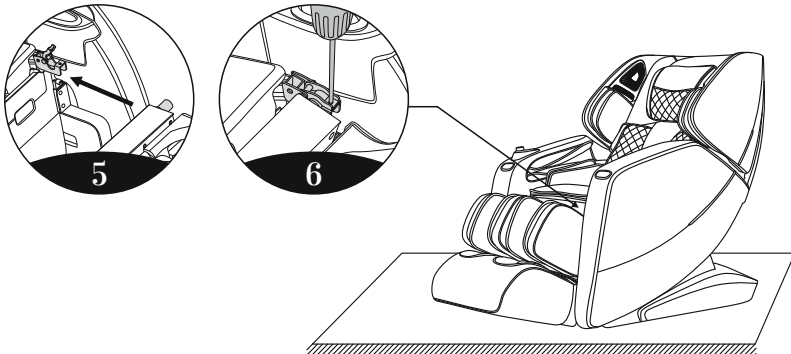

## Method of usage

---

7. After the screw is locked, insert the rear slot of the calf cover into the pin, and then press the front end of the calf cover down and the rotating shaft. the cover is completely parallel and the calf is installed (Figure 7)

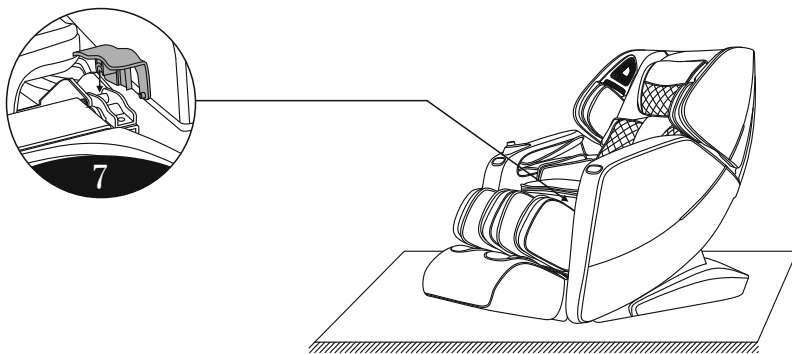

## 9. Head cushion and backrest pad's dismounting and use manual

- Using head cushions can reduce the kneading massage intensity on neck and shoulder, according to your needs to decide whether the head cushions is needed (recommend head cushions). Backrest cushion and backrest connected by zipper (1), head cushions and backrest pad connected by thread gluing (2).

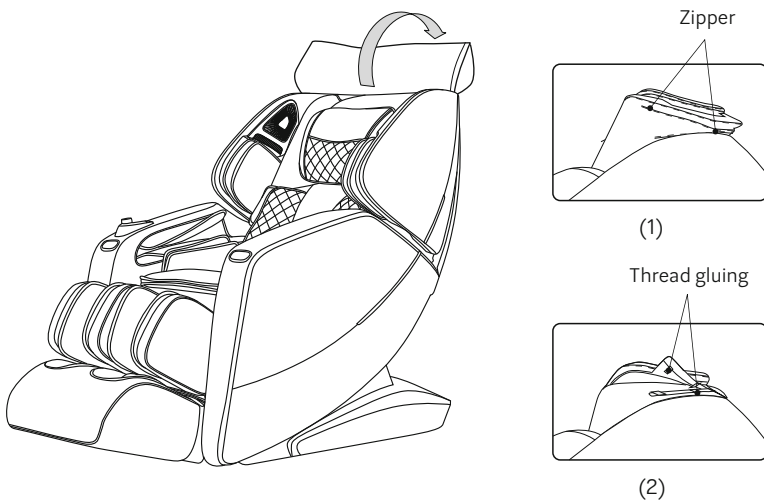

## Method of usage

---

### 10. Floor protection

- Put the heavy massage chairs on the wood floor for a may damage the floor, so please place a carpet or other object to avoid this damage.

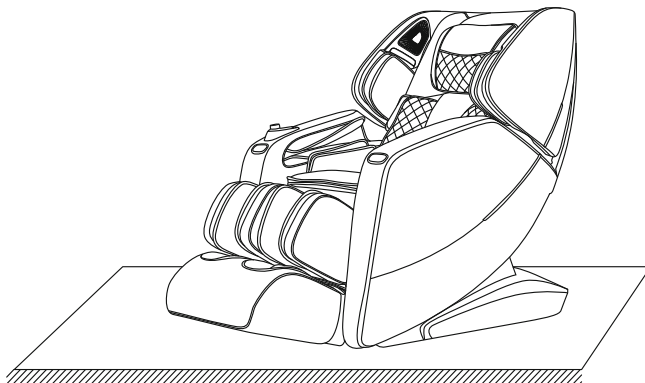

Caution: Do not move the chairs with its wheels on wood floor, rough ground or in a narrow space. Two people are required to lift the chair. During the lifting period, take the calf rest end sealing plate and backrest cover grooves as the force-bearing point (Please do not lift armrest directly.)

### 11. Method of movement

- Pls make sure the cable not unplugged before move the chair , and it needs 2 person to work together to move it .One person raise up the footrest and the other push down the backrest , When the center of gravity of the massage chair is completely on the wheels , it can be easily to move to the suitable location .

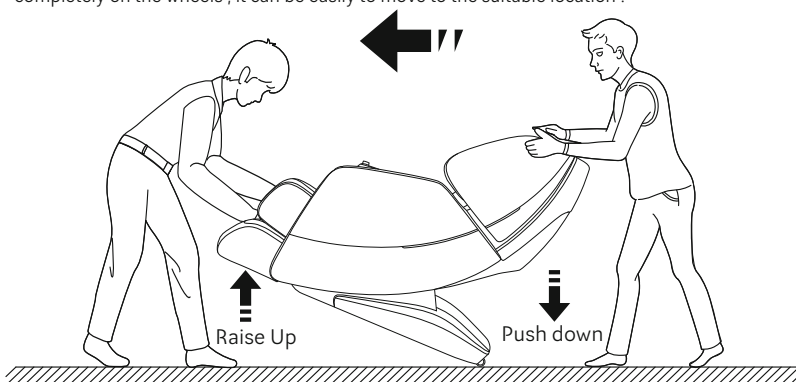

Note: During movement you must turn off the power first and then unplug the power cord and the controller cord.

## Product specification

---

Model: Massaggio Stravagante

Configure: 2

Name: Massage Chair

Rated voltage: 220-240V~ 50Hz/60Hz

Rated power input: 220W

Rated time: 20Min

afety structure: Class I

Material introduction: PVC, PA, steel parts and electric & electron parts

MATERIAL	PU	LEATHER	CLOTH	WOOD

## SAVE THESE INSTRUCTIONS

Dear user, you can contribute to environmental protection. Be environmentally responsible and return your used equipment to the relevant collection point designated by your local administration. The materials used to manufacture the device may be valuable recyclable resources and, if disposed of incorrectly, can pose a risk to the natural environment. Remember - do not dispose of the device together with your household waste.

