

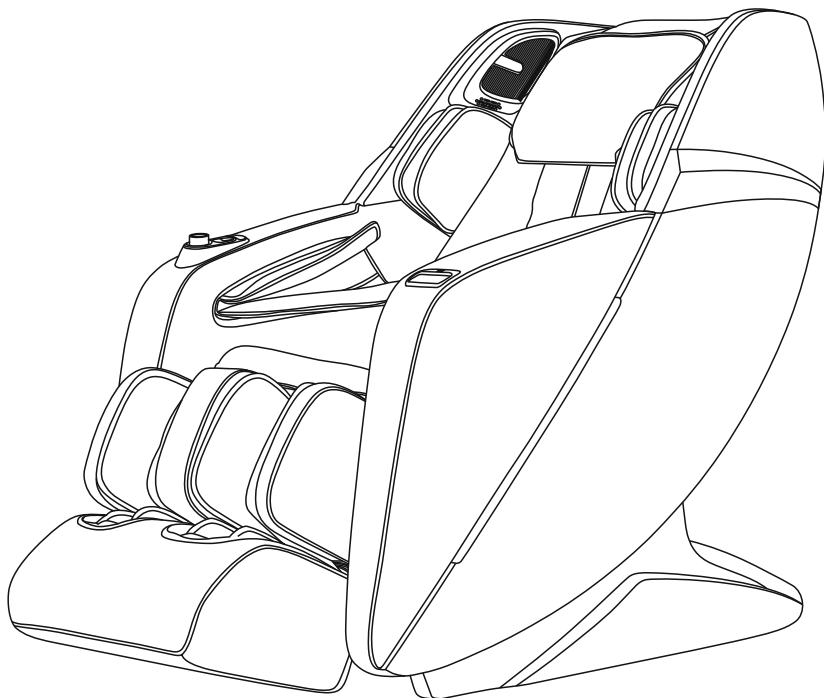

Massaggio Esclusivo 2

User manual



Thanks for purchasing this product. Please read this manual instruction carefully in order to know how to use this product correctly before operation. Please pay more attention to some important safety warning and keep this manual book properly for future use.

Note: Our Company reserves the right to revise the design and description of this product without any further notice. Please refer to the actual color of this product.

CONTENTS

Safety and maintenance	02-03
Use safety warning	04-05
Name and function of components	06
Function	07
Remote interface introduce	08-09
Method of usage:	10
1. Switch power supply on	10
2. Massage function control operation	10-27
3. Handrail shortcut button introduction	28-29
4. Voice control instruction	30
5. Turn off power, stop massage	31
6. Bluetooth Player Operation	31
7. Installing the armrest	31-33
8. Calf installation	33-35
9. Head cushion and backrest pad's dismounting and use manual	35
10. Floor protection	36
11. Method of movement	36
Product specification	37

Safety and maintenance



1. Important Safety Warning.

- Don't allow children to touch moveable part of this product.
- Please use well-grounding power supply suited to this product.
- Please pull out the plug after use or before cleaning to avoid injury or damage to the product.
- Please operate this product according to this manual instruction.
- Don't use accessories which are not recommended.
- Don't use this product outdoors.
- Please read this manual instruction carefully before operation.
- Any other usage that is not listed in this manual instruction is forbidden.
- 20 minutes of usage each time is recommended.
- Please don't use it if the leather is broken or damaged.
- Please don't use it if the cover or leather is damaged.
- Please don't use it if the radiator hole is covered or blocked.
- Please don't drop anything into this product.
- Please don't fall asleep while using this product.
- Please don't use it if drunk or feel unwell.
- Please don't use it within one hour after having meal.
- Please don't make the massage function too strong for avoiding Injury.

2. Environment for usage.

- Please don't use it under high temperature and moist environment such as bathroom.
- Please don't use it immediately while the environmental temperature changes sharply.
- Please don't use it under heavy-dusty or caustic environment.
- Please don't use it where there is not enough space or not good ventilation.

3. People who are not suitable to use this product.

- People who are suffering from osteoporosis are not suitable to use this product.
- People who are suffering from heart disease or carrying electronic medical equipment such as heart pacemaker are not suitable to use this product.
- People who are suffering from fever are not suitable to use this product.
- Pregnant women or women that are in menses period are not suitable to use this product.
- People who got injured or skin disease are not suitable to use this product.
- Children under 14-year old or people mentally unbalanced without being Supervised are not allowed to use this machine.
- People who are told by doctor to have rest or people who feel unwell are not suitable to use this product.
- People whose bodies are wet are forbidden to use this product.
- The appliance has a heated surface. Persons insensitive to heat must be careful when using the appliance.

Safety and maintenance

4. Safety.

- Check the voltage if it is suitable to the specification of this product.
- Don't use wet hand to pull the plug.
- Don't make water go inside this product to avoid electric shock or cause damage to this product.
- Don't damage the wires or change the circuit of this product.
- Don't use wet cloth to clean the electric parts such as switch and plug.
- Be away from this product under power cut state to avoid injury if the power comeback suddenly.
- Stop using this product while it works abnormal, and please consult local agent immediately.
- Stop using this product if you feel unwell, and please consult health care doctor.
- This appliance is not intended for use by persons (including children) with reduced physical, sensory or mental capabilities, or lack of experience and knowledge, unless they have been given supervision or instruction concerning use of the appliance by a person responsible for their safety.
- Children should be supervised to ensure that they do not play with the appliance.
- If the supply cord is damaged, it must be replaced by the manufacturer, its Service agent or similarly qualified persons in order to avoid a hazard.

5. Maintenance.

- This product should be maintained by certain appointed agents, users are prohibited to disassemble or maintain by themselves.
- Please don't forget to cut the power after usage.
- Don't use this product if the socket looses.
- If this product will be left unused for long, please curl up the wires and reserve this product in dry and dustless environment.
- Don't reserve this product under high temperature or near fire and avoid longtime direct sunshine.
- If the detachable cord / supply cord is damaged, it must be replaced by the manufacturer, its service agent or similarly qualified persons in order to avoid a hazard.
- Please clean this product by dry cloth. Don't use thinner, benzene or alcohol.
- The mechanical components of this product are specially designed and made, it is not necessary to be specially maintained.
- Don't use edged res to thrust this product.
- Don't roll or pull this product above uneven ground, it should be lifted before moving.
- Please use it intermittently; don't make this product work continuously for long.

6. Solution of ordinary malfunctions.

- It is nature movement voice if the motor sounds while in usage.
- If the controller can't work normally, please check the plug and socket if they are connected strongly and make sure the switch is turned on.
- If the rated working time is over, the product will automatically activate the power-off button; If this product works continuously for long, the temperature protector will make the product automatically power-off, it should be used again after half an hour's rest.

Use safety warning

Warning

When the footrest lifting, people should not apply pressure on the footrest to avoid the massage chair falling forward to damage the product or cause personal injuries

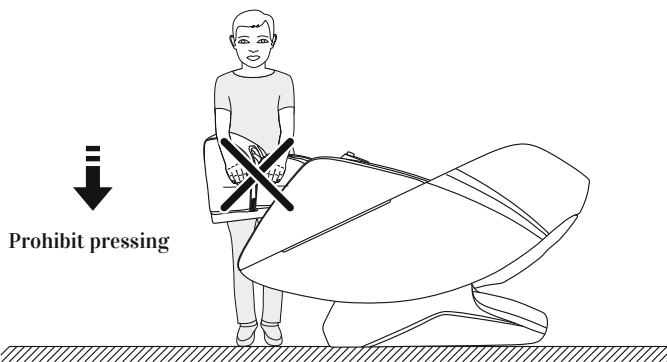

Warning

Before sitting on the massage chair, Please make sure the massage hand cannot place in the seat position, so as avoiding the massage hand to damage the product or cause personal buttocks injuries.

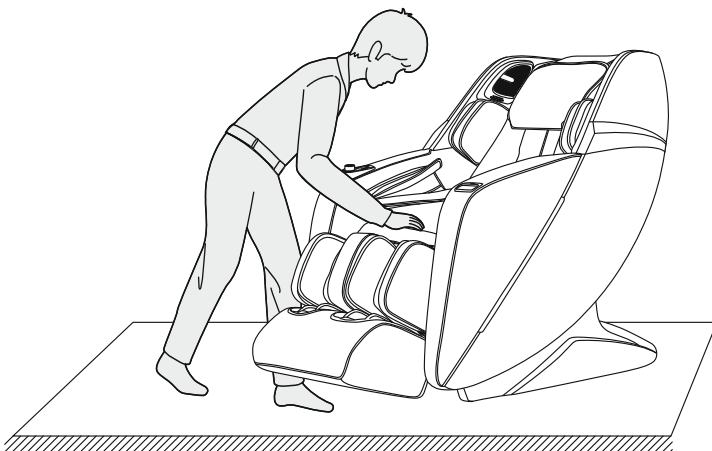

Use safety warning

Warning

Do not strive to pull out the control cable or power cord during standby or power-on state to avoid product damaged or electrocution accidents. Advise you unplug the controller cable and power cord and put away after you use the chair.

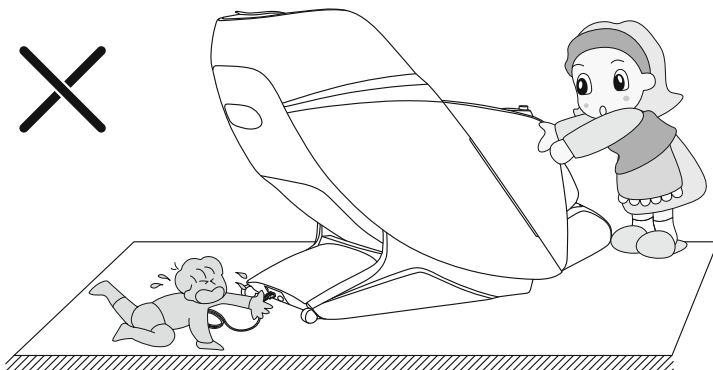

Warning

When turning on the Zero Gravity lying function, be sure to notice whether there are children or pets under the massage table under the bottom of the calf and the backrest to stay or play to avoid product damage and personal injury.

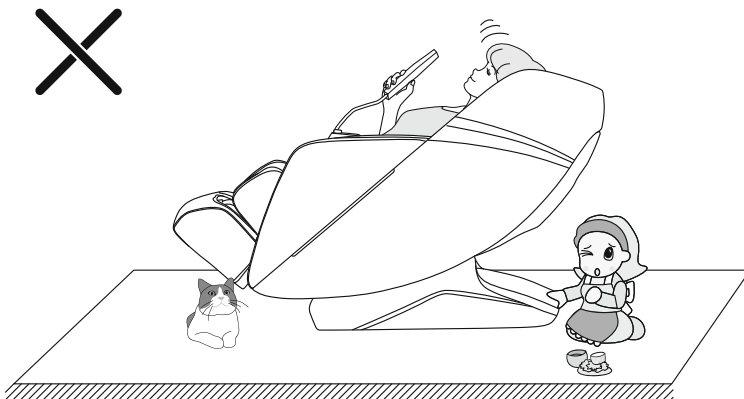

Name and function of components

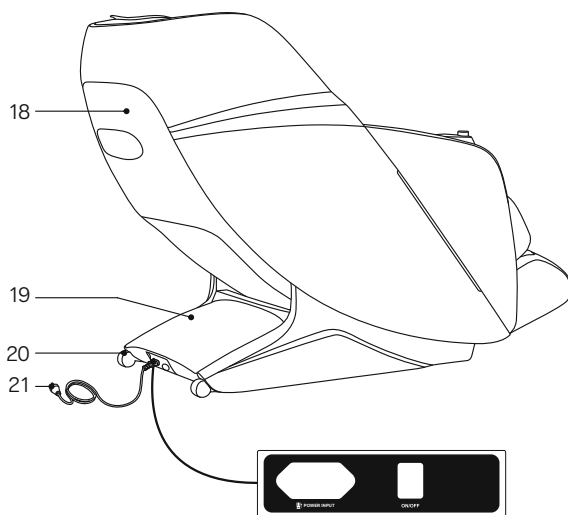
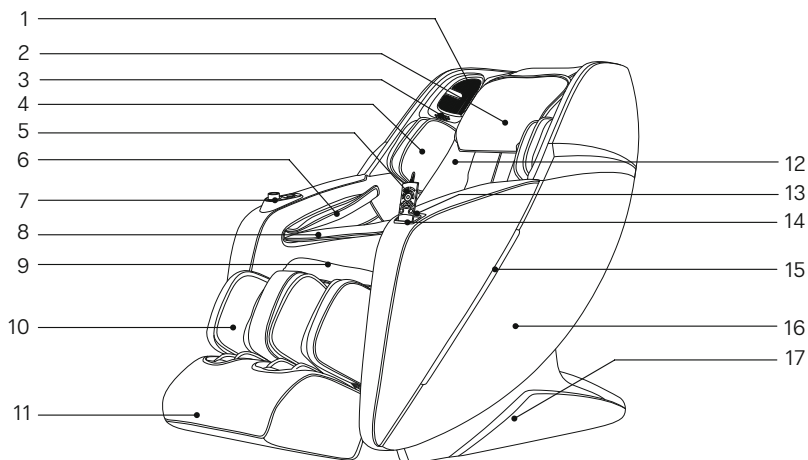

1. 3D digital speakers
(voice control install
in left speaker)
2. Pillow pad
3. Ion air generator
4. Upper arm air bag
component
5. Remote controller
6. Arm air bag component
7. Handrail shortcut button
8. Salient massage with
magnetic therapy
9. Seat cushion
10. Calf rest
11. Foot rest
12. Back cushion
13. USB charging socket
14. Controller slot
15. LED lights
16. Armrest
17. Side panel
18. Back cover
19. PCB box cover
20. Caster
21. Power cord and plug
22. Power cord socket
23. Power switch

22

23

Function

- This product is designed with a group of intelligent and silent 3D massage hand that can move up and down and four-wheel drive.
- There are five kinds of simulated massage modes such as shiatsu, kneading, tapping, kneading and tapping.
- It can automatically detect the shoulder position.
- With eight special automatic massage functions: Fast massage, Comfort massage, Relax massage, Stretch massage, Full Body massage, Spinal massage, Neck & Shoulder massage, Back & waist massage and full air pressure.
- Two memory storage functions: memory I, memory II.
- The upper half manually selects the massage function; there are five kinds of massage position selections such as full, partial, fixed point, upper back and lower back; shoulder lifting, kneading, tapping, shiatsu and kneading and tapping five massage techniques; the massage technique has five speeds that can be adjusted; when massaged in tapping and shiatsu mode, the robot massage ball have three widths to adjust.
- Air massage function: upper arm air pressure massage function (built in 4 airbags), arm air pressure massage function (built in 8 airbags), leg air pressure massage function (built in 6 airbags), foot air pressure massage function (built in 18 airbags), and three levels for air pressure intensity adjustment.
- The back and calf heating function use carbon fiber as an infrared heating source, and three levels for heating temperature adjustment.
- As the backrest reclines down, this product is built to space save by making the chair slides forward.
- The backrest rail adopts "SL" rail technology, which fits perfectly with the curve of the back of the human body and can enjoy close-fitting massage from the head to the thigh.
- Music playback system: built in 3D digital speaker on the left and right arms. The Bluetooth function of the smart device can be used to play music on a wireless connection.
- Intelligent voice control and identification function.
- Leg erection has telescopic regulation function, foot and leg linkage telescopic; When the foot is pushed out of the leg, the hind leg will be raised in the opposite direction. The extension length of the foot is determined according to the length of the user's leg. The extension length of the leg is half of the foot, and the foot and leg are retracted by spring force.
- The right armrest is provided with a Ion air generator, raise button, recline button, Zero Gravity button, pause button, automatic mode button, foot adjustment button, and calf adjustment button.
- Calf rest lifting or recline adjustment, lifting or recline adjustment of leg and back, Zero Gravity I or Zero Gravity II and time setting adjustment function.
- At the bottom of foot have roller massage function, three pairs of rollers massage on toe root; scraping massage function on the arch and heel.
- At the calf have kneading massage function which can relieve the stiffness and stress of calf.
- In the left and right palm air bags, there is a salient massage with a magnetic massage function.
- There have USB charging function in the controller slot at the front end of left arm rest.
- equipped with a Ion air generator at the right armrest
- equipped with TFT color screen manual remote controller.
- Automatic shutdown reset function, massage head automatic reset function.
- The pillow pad uses the two section foldable design that you can decide the using flayer according your request to reduce the massage intensity of neck and shoulder; expand the pillow pad to back to reduce the massage intensity of back. It can be suitable for different people for freedom choose.

Remote interface introduce

Manual remote controller interface

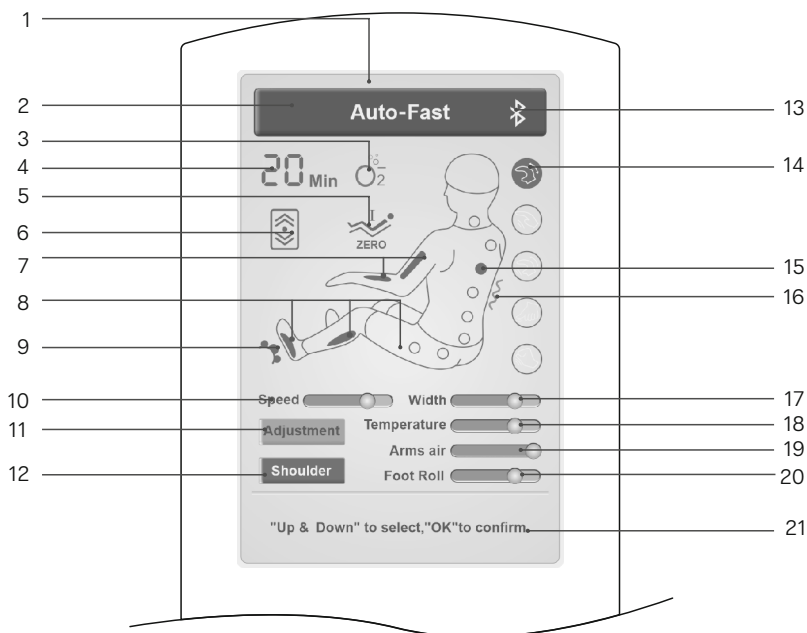

Note: Manual remote controller shows the color, massage function and massage function icon typesetting. Please be subject to the actual products!

- | | |
|---------------------------------------|--|
| 1. TFT color display | 12. Shoulder position adjustment |
| 2. Massage status information display | 13. Bluetooth display |
| 3. Ion air generator display | 14. Massage modes display |
| 4. Time display | 15. Massage position display |
| 5. Zero Gravity display | 16. Back heating display |
| 6. The back stretch display | 17. Width adjustment |
| 7. Arm air pressure display | 18. Heating temperature adjustment |
| 8. Leg and foot air pressure display | 19. Upper body air pressure adjustment |
| 9. Foot roller display | 20. Lower body air pressure adjustment |
| 10. Speed adjustment | 21. The status bar |
| 11. Adjustment | |

Remote interface introduce

Manual controller button

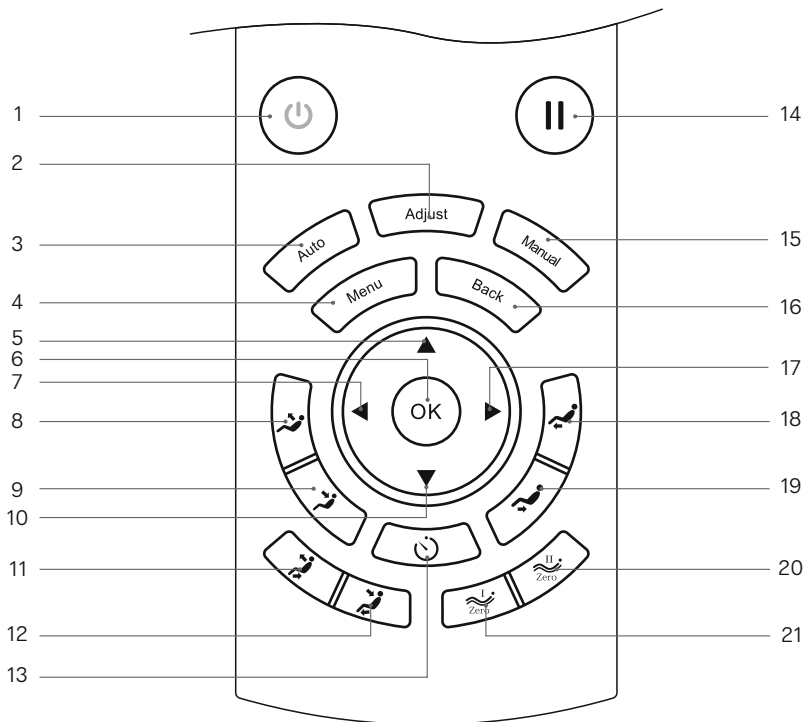

- | | |
|--|--|
| 1. Power button: turn on or off massage chair | 12. Lying down button: massage chair link down |
| 2. Adjustment button: enter the massage function selection interface | 13. Zero Gravity button: adjust massage chair zero gravity |
| 3. Auto button: enter the automatic mode selection interface | 14. Pause button: Pause all the function |
| 4. Menu button: enter main menu interface | 15. Manual button: enter the manual mode selection interface |
| 5. Up button: navigation key up | 16. Return button: return to massage information interface |
| 6. OK button: confirm | 17. Right button: navigation key turn right |
| 7. Left button: navigation key turn left | 18. Calf rest up button: adjust calf rest up |
| 8. Backrest rise button: adjust the backrest rise | 19. Calf rest down button: adjust calf rest down |
| 9. Backrest down button: adjust the backrest down | 20. Foot rest shorten button: adjust foot rest short |
| 10. Down button: navigation key down | 21. Foot rest elongate button: adjust foot rest elongation. |
| 11. Sit up button: massage chair link up | |

Method of usage

1. Switch power supply on

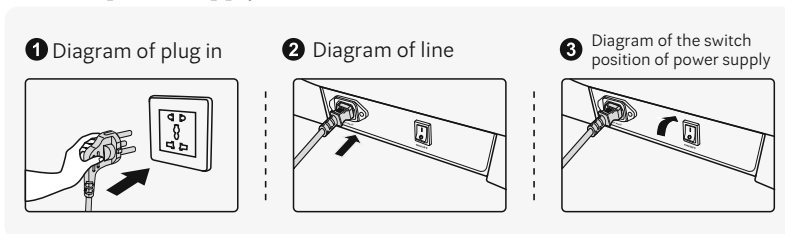

2. Massage function control operation

1). Czuwanie

- After the massage chair cannot enter any mode operation in standby mode.

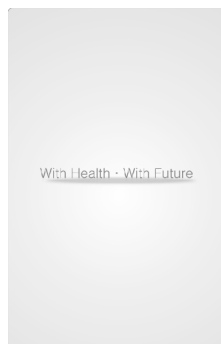

2). Start to massage

- Press "Power" button to start massage, enter the boot screen, backrest maintains the default position.
- After automatically lying down to the default position, massage chair will automatically detect the shoulder position and body (note: fast mode only detect shoulder position, other modes detect whole body and shoulder position), waiting the detection finish. Or you can press "confirm" button, the massage chair will directly start to massage in default without shoulder position and body sensing.

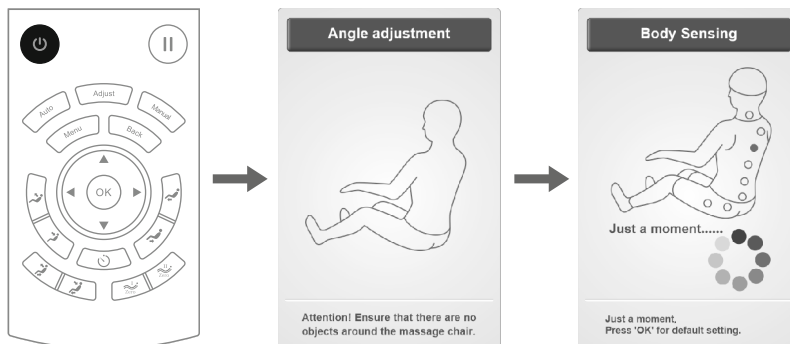

Method of usage

- After testing the shoulder position, sounded with "di-di-di" notification tone, you can adjust the shoulder position by press up or down button according to users' height in small scale. There have 11 levels for shoulder adjustment. If without adjustment in 10 seconds, then into the massage function automatically. Or directly press "confirm" button enter the massage immediately. If massage chair does not test shoulder position, the massage will start with default position.

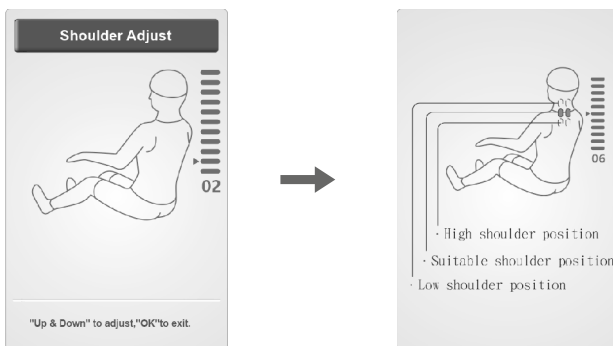

Button	Description
	Move the massage balls upward to a suitable position.
	Move the massage balls downward to a suitable position.

- After entering the massage modes, the shoulder position can adjusted in shoulder adjustment interface when at the operating status interface.

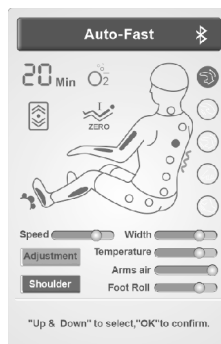

Method of usage

3). Stop button

· In massage process, press “stop” button, all the massage function will stop; press it again, it will go with massage function before stop. If the time exceeded 20 minutes, all the massage function will turn off.

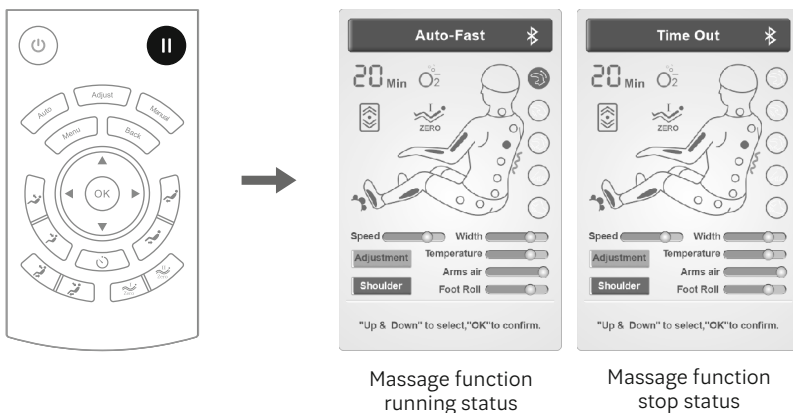

4). Menu button

· Press “menu” button to enter the main menu massage function selection interface includes automatic function, manual mode, adjustment, customize, set, equipment information function interface.

· Press “up” or “down” button choose the menu, press “confirm” button to confirm enter the choosing menu interface. Press “return” button to return the function selection information interface.

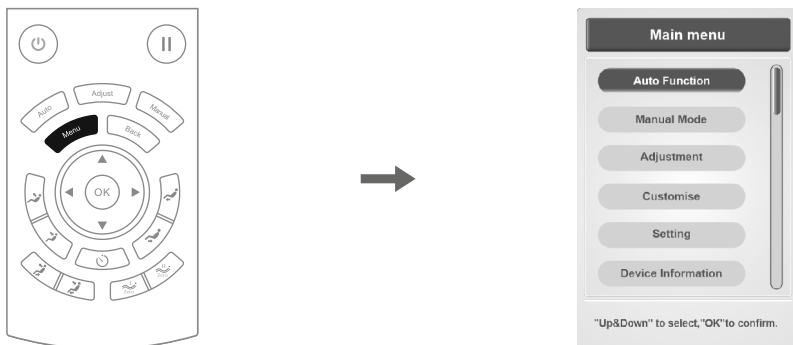

Method of usage

5). Automatic function (automatic button also can press directly to automatic function interface)

- Press "menu" button to enter main menu interface, choosing automatic function icon: Fast massage, Comfort massage, Relax massage, Stretch massage, Full Body massage, Spinal massage, Neck & Shoulder massage, Back & waist massage and full air pressure.
- Press "up" or "down" button to choose massage function, press "OK" button to confirm enter the choosing massage function. Press "return" button to return to function selection information interface.

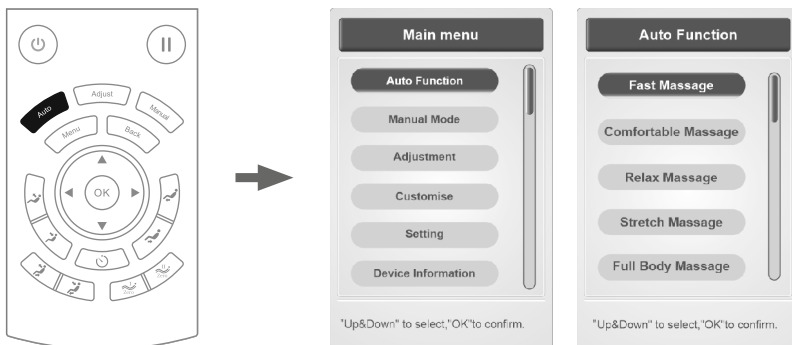

Function	Description
Fast massage	Fast to experience all the massage effect.
Comfort massage	The most comfortable massage experience.
Relax massage	Gentle and comfortable depth massage to relax body and relieve tired.
Stretch massage	It uses the waist airbag pressure to swing around to form a twisting massage function, which relieves sedentary and causes tension in waist muscles.
Full body massage	Depth massage, recall body energy.
Spinal massage	Focus on vertebra massage to relax body.
Neck& shoulder massage	Point to neck and shoulder massage mode, relieve muscles sore and tired be useful effective massage.
Back & waist massage	Focus on the back and waist massage to relieve back and waist sore.

Note: The automatic functions which have been chosen will all display in massage function status, you can directly press "return" button to check the running status.

Method of usage

6). Manual mode (manual button directly enter manual mode interface)

- Press "menu" button to enter main menu interface, choose manual mode icon: include message mode, message position, air pressure and other message function.
- Press "left" of "right" button to change submenu, then press "up" or "down" button to choose message function, press "return" button to return operating information interface.

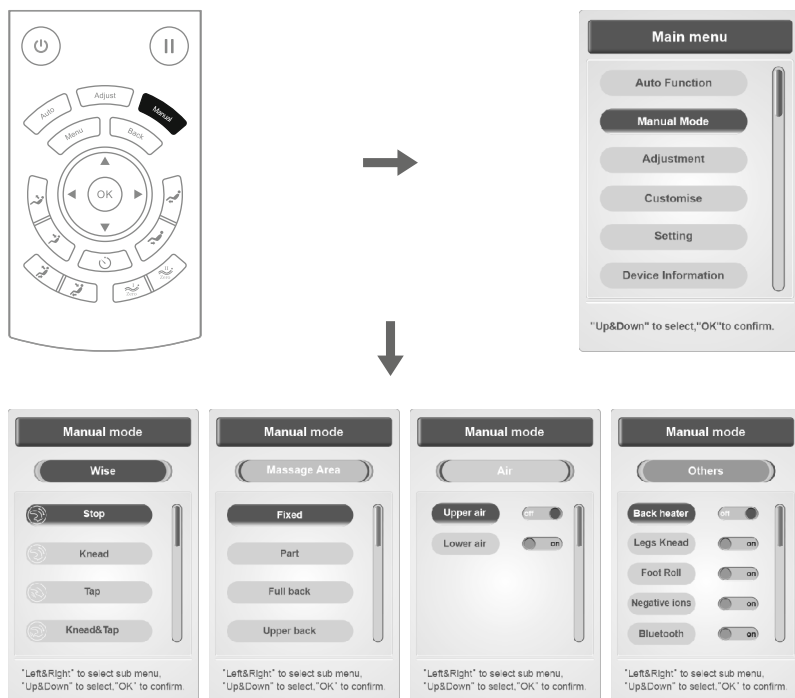

A. Manual mode (manual button-massage mode)

- Manual(mode): Include six message modes such as kneading, tapping, kneading and tapping, shiatsu, 3D, shoulder lifting. In tapping and shiatsu mode, the width can be adjusted. Other message modes can adjust the speed except stop.
- Press "up" or "down" button to choose message mode icon, press "OK" button to confirm the message mode is starting.

Method of usage

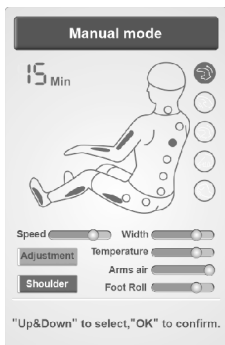

Note: click stop icon, all massage function will stop; choose one massage mode icon will start one massage mode.

Function	Description	
Knead	Speed	Five levels speed can be adjusted Three levels width can be adjusted
Tap	Speed and width	
Knead&Tap	Speed	
Shiatsu	Speed and width	
Knock	Speed and width	

B. Manual mode (manual button-massage position)

- Manual mode(massage position): Massage fixed point, partial, full back, upper back and lower back.
- Press "up" or "down" button to choose partial massage function icon, press "OK" button to confirm.

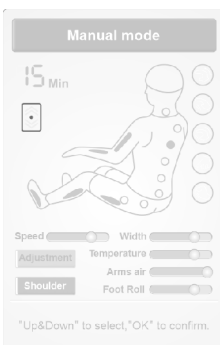

Fixed point

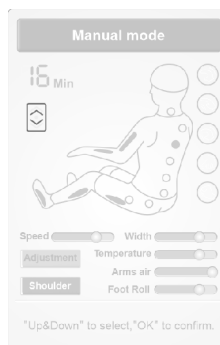

Partial

Method of usage



Full back

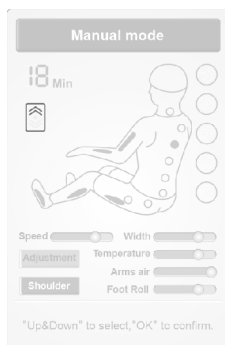

Upper back

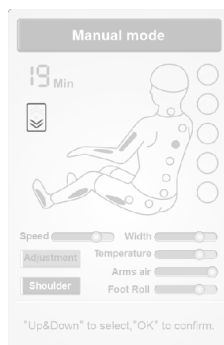

Lower back

Function	Description	
Fixed	Massage at fixed point	When choosing fixed point and partial massage modes, you can adjust the massage range by pressing "up" or "down" button.
Part	Partial massage back and forth in small range	
Full back	Full back massage back and forth	
Upper back	Upper back massage back and forth	
Lower back	Lower back massage back and forth	

C. Manual mode (manual button-air pressure)

- Manual mode(air pressure): include upper body air pressure and lower body air pressure massage function.
- Press "up" or "down" button to choose different air pressure massage function, press "OK" button to confirm.

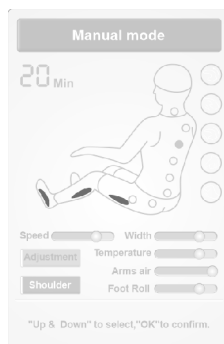
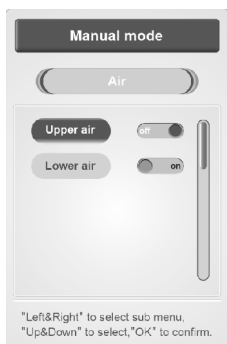

Method of usage

Function	Description
Upper air	Switch on or off upper body air pressure massage function
Lower air	Switch on or off lower body air pressure massage function

D. Manual mode (manual button-extra)

- Manual mode(extra): Include heating, foot roller, Ion air generator , Bluetooth and so on massage function.
- Press "up" or "down" button to choose massage function, press "OK" button to switch on or off the massage function.

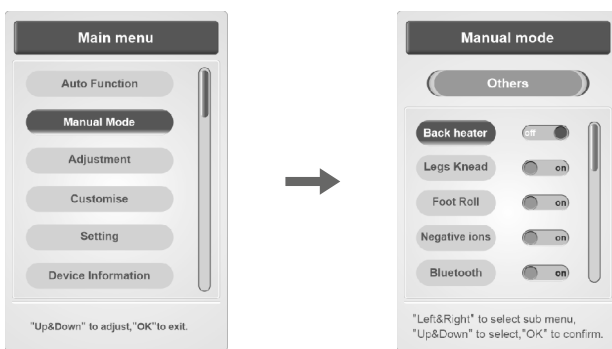

· Manual mode (extra-back heating)

- Press "OK" button to choose switch on or off heating massage function, start 3 minutes will have warm.
- Press "up" or "down" button to choose other massage function, press "return" button to return the operating information interface.

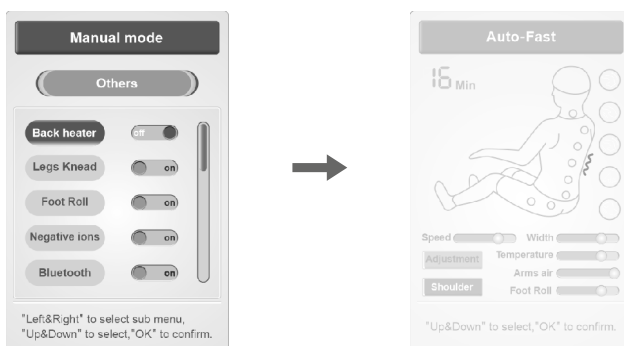

Method of usage

· Manual mode (extra-calf kneading)

- Press "OK" button to choose switch on or off calf kneading massage function.
- Press "up" or "down" button to choose other massage function, press "return" button to return the operating information interface.

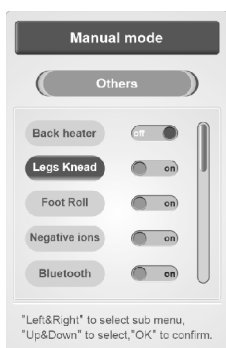

· Manual mode (extra-foot roller)

- Press "OK" button to choose switch on or off foot roller massage function.
- Press "up" or "down" button to choose other massage function, press "return" button to return the operating information interface.

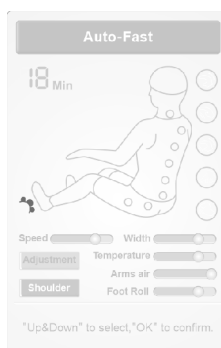
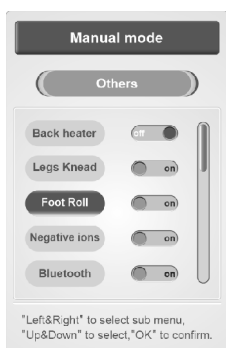

Method of usage

· Manual mode (extra- Ion air generator)

- Press "OK" button to choose switch on or off Ion air generator massage function.
- Press "up" or "down" button to choose other massage function, press "return" button to return the operating information interface.

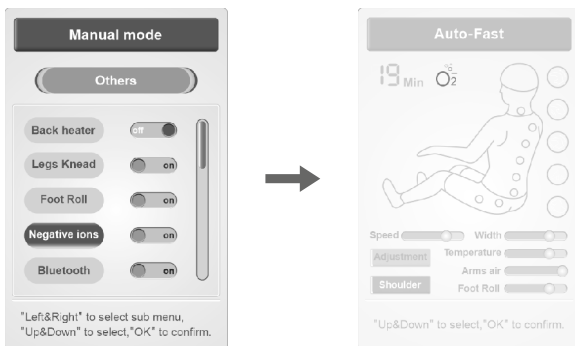

· Manual mode (extra-Bluetooth)

- Press "OK" button to choose switch on or off Bluetooth function.
- After connect the Bluetooth in massage chair with source device which have Bluetooth. The Bluetooth function of the smart device can be used to play music on a wireless connection.
- Press "up" or "down" button to choose other massage function, press "return" button to return the operating information interface.

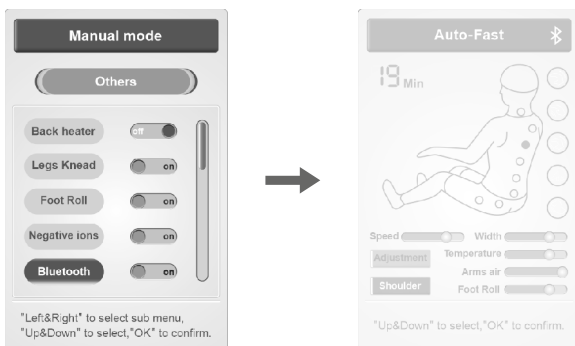

Method of usage

7). Adjustment function (adjust button-directly press "adjust" button to enter adjustment function interface)

- Press "menu" button to enter main menu interface, choose adjustment function icon: Include massage mode, massage range, massage intensity and other massage adjustment function.
- Press "left" or "right" button switch to submenu function, choose massage function in menu, then press "up" or "down" button to select adjust function. Press "OK" button to confirm or press "return" button to return to operating information interface.

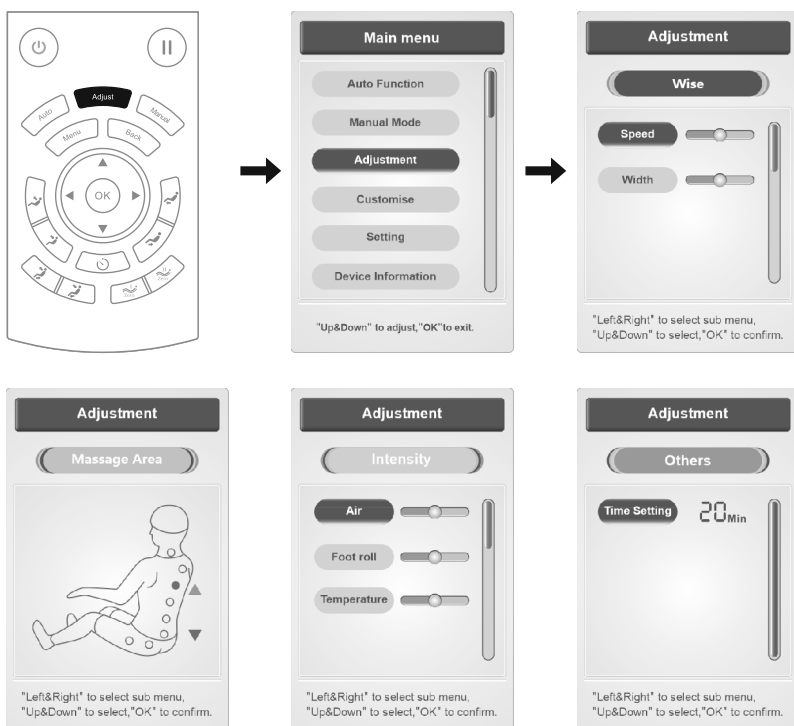

Method of usage

A. Adjustment function (adjust button-massage mode)

- Adjustment function(massage mode): adjust massage mode include speed, width, intensity and so on.
- Press "up" or "down" button to choose speed or width function, press "OK" button to adjust speed and width levels.

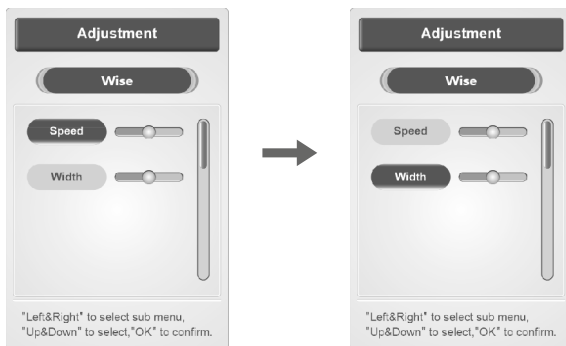

Note:

- Speed: Five levels for massage speed adjustment.
- Width: Five levels for massage width adjustment when in tapping and shiatsu mode.

B. Adjustment function (adjust button-massage range)

- Adjustment function(massage range): When at fixed point or partial massage range, press "up" button not release the massage head will rise or stop; press "down" button not release the massage head will go down or stop. Press "up" or "down" button to adjust massage range.

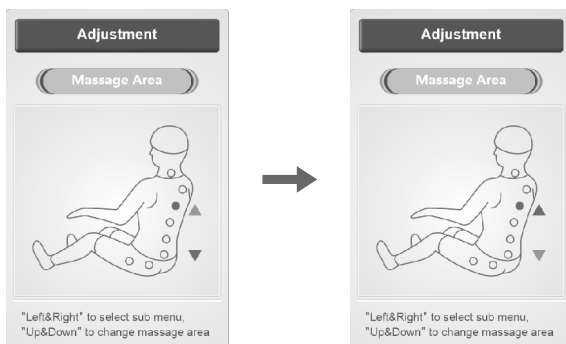

Method of usage

C. Adjustment function (adjust button-intensity)

- Adjustment function (adjust button-intensity): Include upperbody air pressure, lower body air pressure, foot roller. There have three levels to adjust.
- Press "up" or "down" button to choose air pressure intensity or foot roller intensity, press "OK" button to adjust intensity.

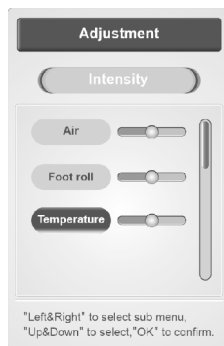
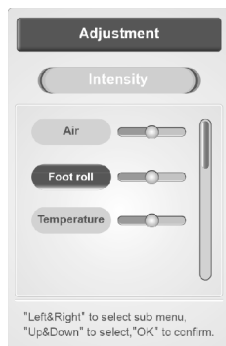
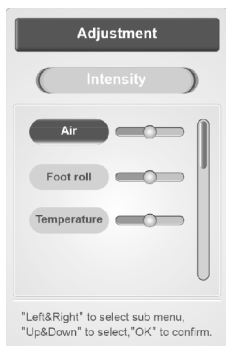

D. Adjustment function (adjust button-other adjustment)

- Adjustment function (other adjustment): Timing at present. Press "OK" button one time with 5 minutes added. When above 40 minutes, it will return to zero.
- Press "OK" button to adjust time (press "OK" button one time, 5 minutes added, 5 at least, 40 at most, in turn)

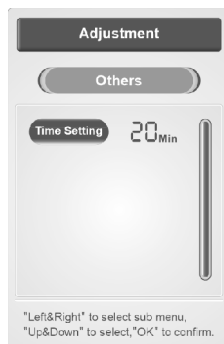

8). Customize

- Press "menu" button to enter main menu select "customize" function, enter customize function interface include storage and transfer function such as program memory I, program memory II or transfer function.
- Press "left" or "right" button to choose storage or transfer, press "OK" button to confirm.
- Press "up" or "down" button to choose program memory I and program memory II
- Storage: Save all current massage mode, air pressure, angle and other massage function.
- Transfer: Retrieval previous massage mode, air pressure, angle and other massage function.
- Press "return" button to return operating information interface.

Method of usage

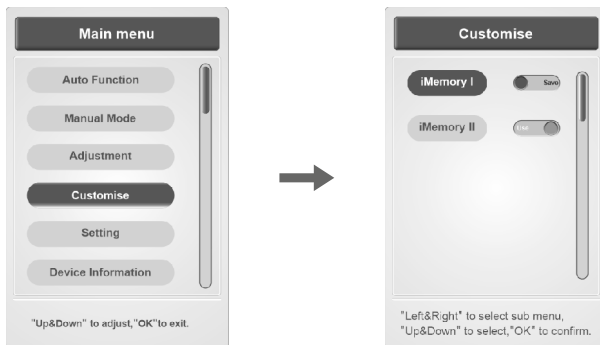

9). Setting

- Press "menu" button to enter main menu interface, choose "setting" function icon, enter setting interface include language, backlight, lock screen and so on.
- Press "left" or "right" button to switch to submenu. Press "up" or "down" button to select function or press "return" button return to operating information interface.

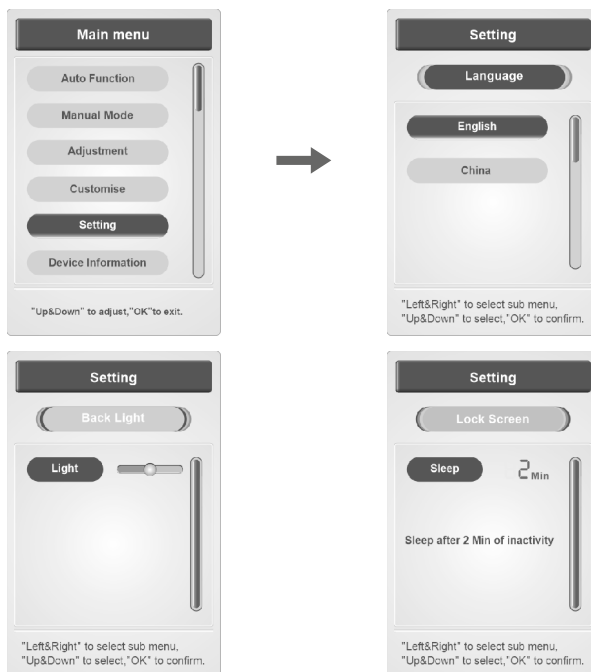

Method of usage

A. Setting (language)

- Setting (language): set Chinese or English language.
- Press "up" or "down" button to choose one language, press "OK" button to confirm.

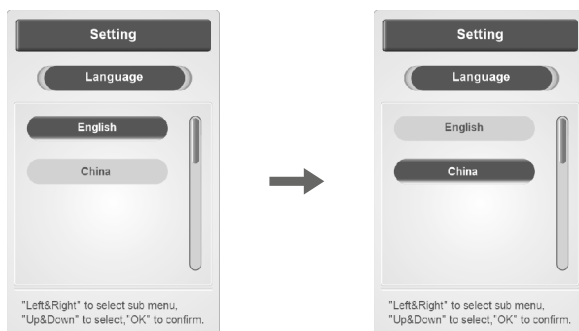

B. Setting (lock screen)

- Setting (lock screen): Press "OK" button to adjust lock time, lock time have five kinds: 15 seconds, 30 seconds, 1 minute, 2 minutes or never lock, press "OK" button to cycle adjustment. Press "return" button return to operating information interface.

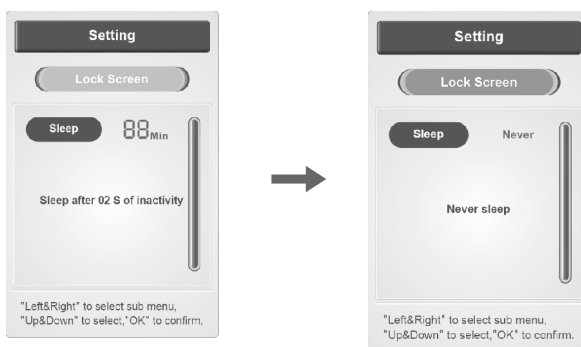

Method of usage

C. Setting (backlight)

- Setting (backlight): five levels for light adjustment. Press "return" button return to operating information interface.



10). Equipment information

- Press "menu" button to enter main menu interface to choose equipment information function, display current equipment information.
- Press "up" or "down" button to select, press "OK" button to confirm. Press "return" button return to operating information interface.

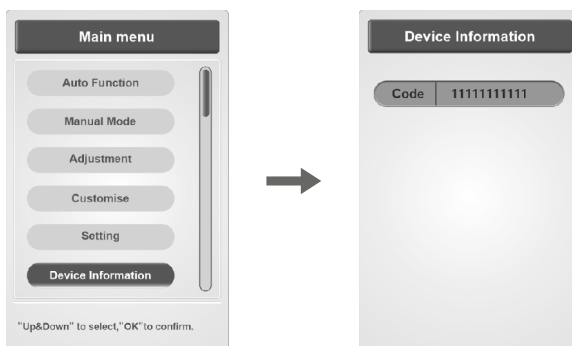

Method of usage

11). Zero Gravity button

- Press "Zero Gravity" button to adjust zero gravity position, choose "Zero Gravity I" or "zero gravity II" according to your requirement.

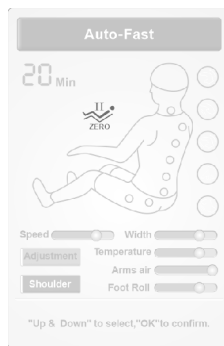
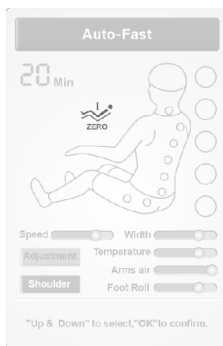
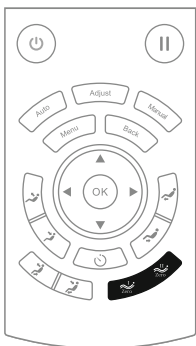

Function	Description
	Zero Gravity I: adjust to Zero Gravity I angle.
	Zero Gravity II: adjust to Zero Gravity II angle.





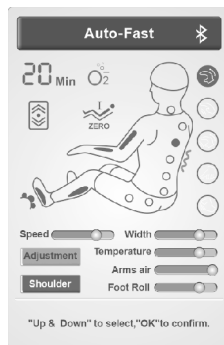
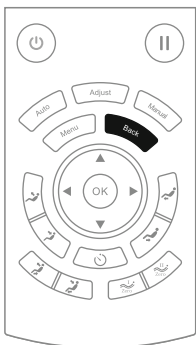



12). Return button

- When adjust massage function, if you want return to operating information interface, press "return" button.



Method of usage

13). Angle adjustment button

Function	Description
	Calf rest up button: press to rise, release to stop; manually set the length of footrest.
	Calf rest down button: press to go down, release to stop; manually set the length of footrest.
	Backrest up button: press to rise, release to stop.
	Backrest down button: press to go down, release to stop.
	Link up button: press to rise backrest with calf rest go down, release to stop; manually set the length of footrest.
	Link down button: press to get down backrest with calf rest rise, release to stop; manually set the length of footrest.
	Zero Gravity I button: Automatically adjust the position of calf rest and back rest to zero gravity I position.
	Zero gravity II button: Automatically adjust the position of calf rest and back rest to zero gravity II position.
	Timing button: timing adjustment, it will add 5 minutes every time you press it. If the time exceeded 40 minutes, it will return to the minimum time.





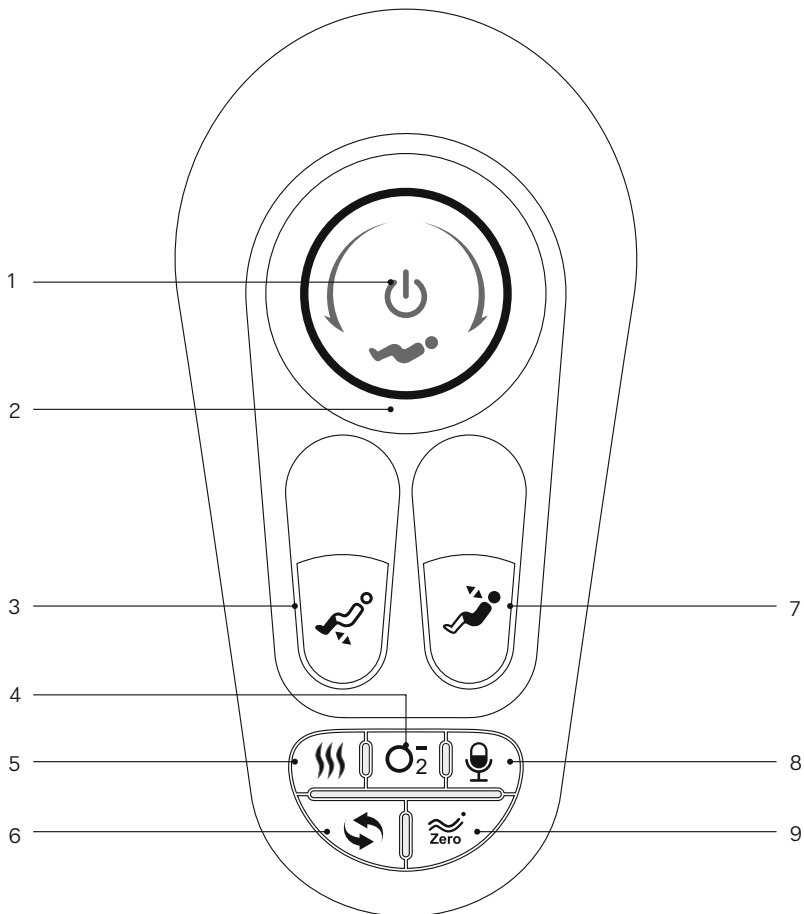



Method of usage

3. Handrail shortcut button introduction



1. Power button: switch on (press it in seconds to stop) or off massage chair.
2. Link adjustment button: link adjust back rest up and down.
3. Calf rest lifting button: adjust calf rest up and down.
4. Ion air generator: switch on or off ion air generator.
5. Heating button: switch on or off heating.
6. Automatic button: switch on or off massage function.
7. Recline button: adjust backrest lying down angle.
8. Voice control wake button: wake up the Voice control function.
9. Zero Gravity button: adjust angle of Zero Gravity.

Method of usage

Function	Description
	<p>Power button: press in a second to stop, press in 3 seconds to switch on or off. If the pause time exceeds 20 minutes, all massage function are automatically turned off.</p>
	<p>Linkage lie down button: rotate button clockwise allow backrest goes down slowly, in the meantime, the calf goes up, release the button will cease backrest goes down and calf goes up.</p> <p>Linkage rise up button: rotate button counterclockwise allow backrest goes up slowly, in the meantime, the calf goes down, release the button will cease backrest goes up and calf goes down.</p>
	<p>Calf rest up button: press to rise foot rest, release to stop.</p> <p>Calf rest down button: press to get down foot rest, release to stop.</p>
	<p>Backrest rising key: lift the key up and slowly descend the backrest, and release it to stop the backrest falling.</p> <p>Backrest down key: press the key down to backrest up slowly, and release it to stop backrest up.</p>
	<p>Heating button: switch on or off heating function.</p>
	<p>Ion air generator button: switch on or off Ion air generator.</p>
	<p>Voice control wake-up button: press this button to wake up the voice control function.</p>
	<p>Automatic mode button: press to switch automatic massage function each time.</p>
	<p>Zero Gravity button: automatically adjust calf rest and back rest to the position of zero gravity, there have two Zero Gravity lying down mode in turn.</p>

Method of usage

4. Voice control instruction

- When the massage chair is open or in standby mode, say "hi, Alice" or press the voice control wake-up button on the right armrest to wake up the voice control function.
- After the successful wake-up, the massage chair will reply "I am here". At this time, the voice control entry corresponding to the function is realized within 6 seconds. After the massage chair is respond, the corresponding voice control function can be realized; if did not correctly say any voice entry for more than 6 seconds, the voice control function automatically turns off and needs to be reawakened.
- Note: When waking up the voice control function, please use Mandarin, the speech rate is moderate, Voice commands should be follow up the Voice entry.

Voice control enter		
Awakening words: "hi Alice". Answer: I am here.		
Serial No	Voice control entry	Answer entry
1	Massage on	Answer: Ok, massage on.
2	Massage close	Answer: Ok, massage close
3	Comfort Massage.	Answer: ok, comfort massage
4	Relax massage.	Answer: ok, relax massage
5	Full body massage.	Answer: ok,full body massage
6	Neck and shoulder massage.	Answer: ok,Neck and shoulder massage
7	Back and waist massage.	Answer: Ok,back and waist massage
8	Stretch massage.	Answer: ok,stretch massage
9	Fixed massage.	Answer: ok,fixed massage
10	Change the other mode.	Answer: Ok, change the other mode
11	Go little down.	Answer: Ok, go little down
12	Go little up.	Answer: Ok, go little up
13	Open the air pressure.	Answer: OR, Open the air pressure
14	Close the air pressure.	Answer: OR , Close the air pressure
15	Up the seat position.	Answer: Ok, Up the seat position
16	Down the seat position.	Answer: Ok, Down the seat position
17	Stop adjustment.	Answer: Ok, stop adjustment

Method of usage

5. Turn off power, stop massage

- During the massage process, press the power switch key to immediately turn off all massage functions, the seat back and the foot pad are reset, the massage time is up, and all massage functions are immediately turned off, and the seat back and the foot pad are not reset.
- Cut off the power supply of the whole machine, the figure (schematic diagram of the whole machine power cut).

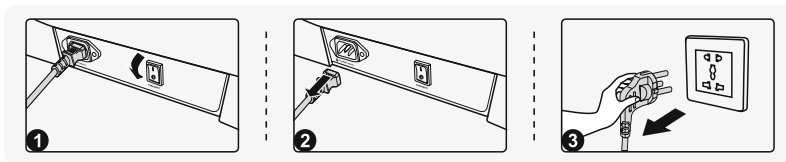

- ❶ Schematic diagram of the whole machine power turning off.
- ❷ Schematic diagram of unplugging the whole machine wiring.
- ❸ Schematic diagram of unplugging the power plug.

6. Bluetooth Player Operation

1. Enter the smart device manual and open the Bluetooth function to search the new Bluetooth devices .
2. Will find the bluetooth named like (IMCM-XXXX),choose it to pair with the chair .
3. Turn on the Music Player in the smart device .

7. Installing the armrest

- Locate the connecting plug and air pipe (two wires, two air pipes) corresponding to the armrests from the rail frame and pierce them from the rear end of the rail frame (Figure 1).
- After passing the connector plug from the rear end of the rail frame, corresponding to each pair of wiring plugs and air hoses (docking according to the mark on the physical pair wiring) (Figure 2).

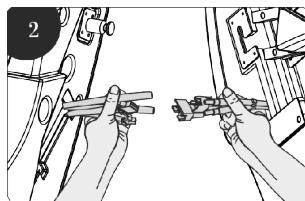
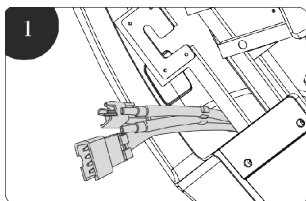

Method of usage

- The connector from the rail steel frame is inserted firmly with the armrest connector, and the air hose connector is also inserted into the position (Figure 3).
- After connecting with the corresponding connecting lines, gently insert the middle of the steel pipe in the middle of the guide rail steel frame into the bottom of the guide rail steel frame, and take care to avoid the tracheal collapse (Figure 4).

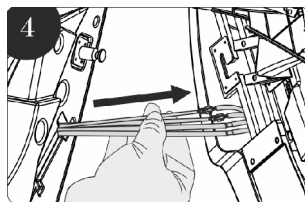
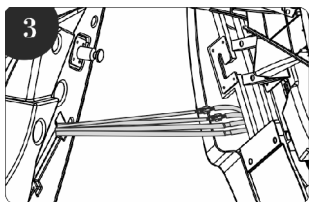

- Hold the front and rear ends of the armrests with both hands, first insert the limit shaft at the rear end of the armrest into the limit shaft card at the lower end of the rail steel frame, then push the armrest up slightly and check whether the armrest limit shaft is inserted firmly (Figure 5).
- After inserting the rear end of the armrest, hook the front end of the armrest into the steel tube of the seat frame and press down the front end of the armrest; then gently shake the armrest to check whether the front and rear ends of the armrest are in place (Figure 6).

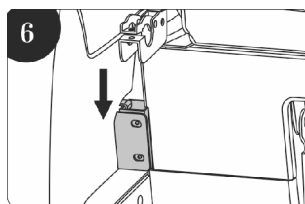
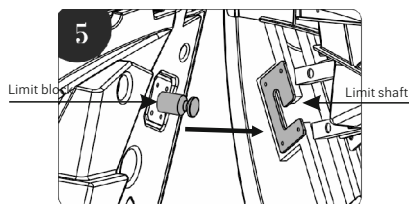

- Align the mounting holes on the steel frame at the front end of the fixed armrest, and then tighten the two M5×14-12.9 black zinc environmentally friendly hexagon socket head cap screws and a 6×12×1.5 black zinc with the supplied 4# hex wrench. The eco-friendly flat pad secures the armrest to the frame steel tube (Figure 7).
- Use 6 ST4.2*12 screws to secure the rear end of the armrest to the space capsule (Figure 8).

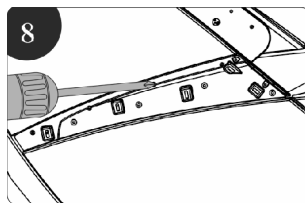
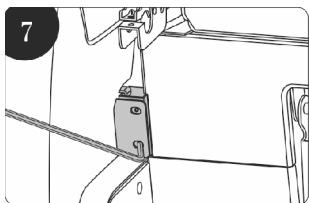

Method of usage

- Fasten the five metal fasteners on the trim to the corresponding buckles of the armrest (Figure 9).

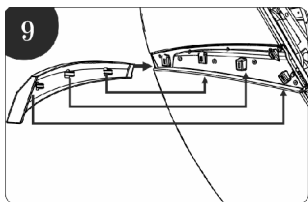

8. Calf installation

1. Cut the connecting wire and the air pipe tie fixed on the steel pipe first (Figure. 1).
2. Connect the connecting wire and the air pipe and the leg joint in the lower end of the frame, and confirm whether the docking is in place. Then insert the docking cable and the air pipe from the lower end of the frame into the lower side of the frame, and pay attention to the plug. Avoid tracheal dying when entering (Figure 2).

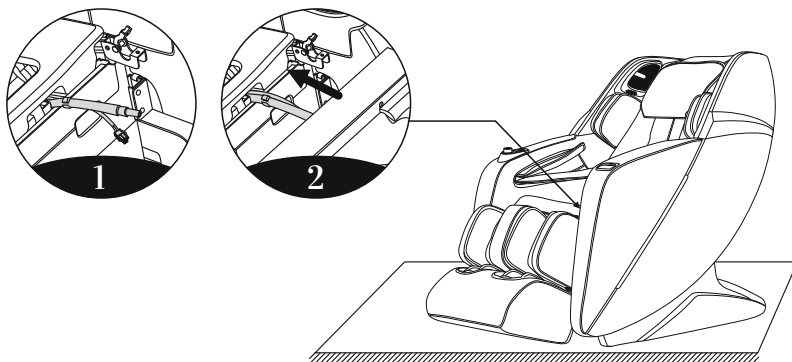

Method of usage

3. Insert the rotating inner sleeve and the rotating outer sleeve into the left side of the calf and the right side of the lower leg (note: the large step must face inward) (Figure 3).
4. Open the calf support hinge cover on the left and right mounts of the massage chair (Figure 4).

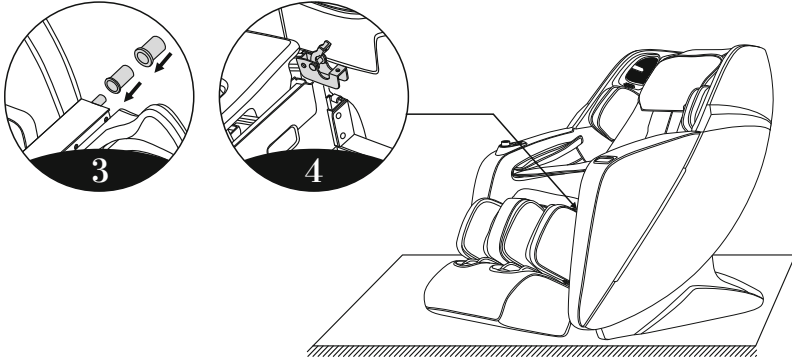

5. Then hang the lower leg (left and right shaft) into the frame support hinge plate at the same time (figure 5).
6. Cover rotating shaft cover, press calf rotating cover, and then tighten calf rotating cover board with two M5×14-12.9 screws and a 6×12×1.5 flat pad by supplied 4# hex wrench. (Fig. 6)

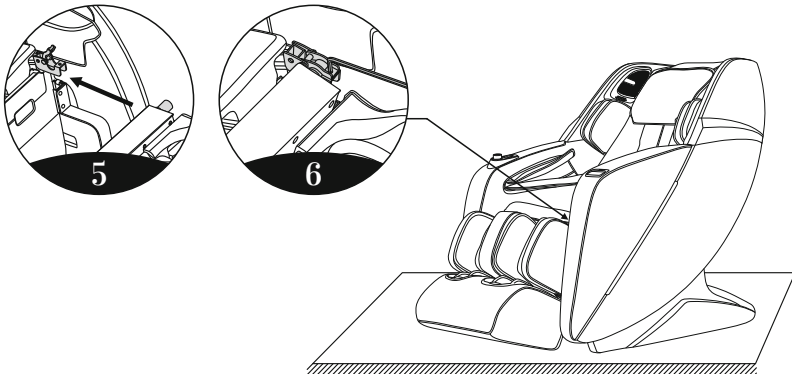

Method of usage

7. After the screw is locked, insert the rear slot of the calf cover into the pin, and then press the front end of the calf cover down and the rotating shaft. the cover is completely parallel and the calf is installed (Figure 7)

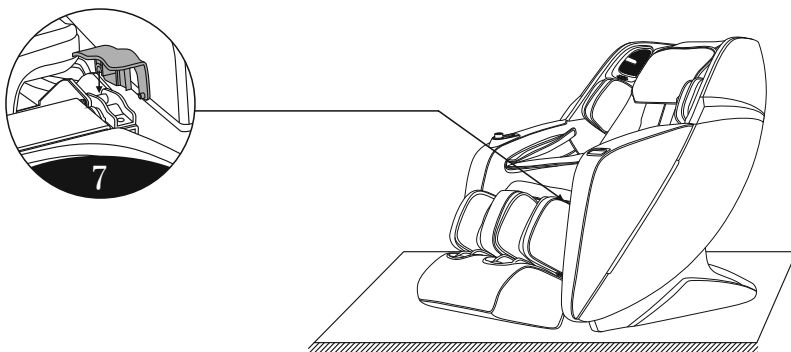

9. Head cushion and backrest pad's dismounting and use manual

- Using head cushions can reduce the kneading massage intensity on neck and shoulder, according to your needs to decide whether the head cushions is needed (recommend head cushions). Backrest cushion and backrest connected by zipper (1), head cushions and backrest pad connected by thread gluing (2).

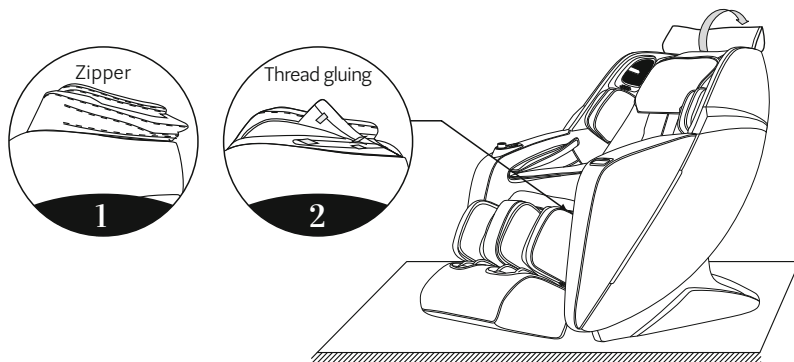

Method of usage

10. Floor protection

- Put the heavy massage chairs on the wood floor for a may damage the floor, so please place a carpet or other object to avoid this damage.

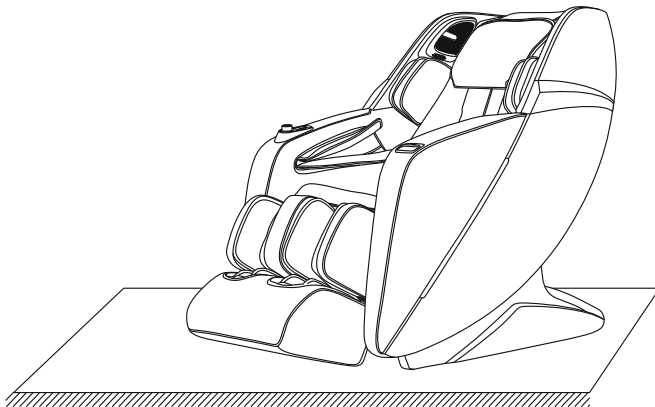

Caution: Do not move the chairs with its wheels on wood floor, rough ground or in a narrow space. Two people are required to lift the chair. During the lifting period, take the calf rest end sealing plate and backrest co

II. Method of movement

- Make sure that all wires are far above the ground, tilt the backrest backward to a certain degree (with the gravity center resting on the wheels), push the chair forward or backward with your hands and finally resume the chair to the normal position in a slow and gentle manner.

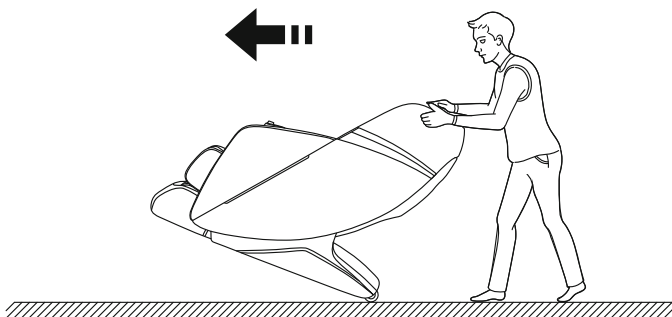

Note: During movement you must turn off the power first and then unplug the power cord and the controller cord.

Product specification

Model: Massaggio Esclusivo

Configure: 2

Name: Massage Chair

Rated voltage: 220-240V~ 50Hz/60Hz

Rated power input: 220W

Rated time: 20Min

Safety structure: Class I

Material introduction: PVC, PA, steel parts and electric & electron parts

MATERIAL	PU	LEATHER	CLOTH	WOOD

SAVE THESE INSTRUCTIONS

Dear user, you can contribute to environmental protection.
Be environmentally responsible and return your used equipment to the relevant collection point designated by your local administration. The materials used to manufacture the device may be valuable recyclable resources and, if disposed of incorrectly, can pose a risk to the natural environment.
Remember - do not dispose of the device together with your household waste.

